

Tecnico — 2016
/ Europe.
*Tavolo, Terra,
Sospensione, Soffitto,
Parete, Esterno.*

FOSCARINI

Tecnico — 2016
Europe

FOSCARINI

Index

Tavolo →



Anisha
→ p. 014



Behive
→ p. 015



Binic
→ p. 018



Birdie
→ p. 016



Birdie Metal
→ p. 017



Caboche
→ p. 019



Doll
→ p. 020



Esa
→ p. 021



Gregg
→ p. 022



Kurage
→ p. 023



Lumiere
+ Lumiere 25th
→ p. 024/026



Lumiere xxl + xxs
→ p. 027



Magneto
→ p. 028



Plass media
→ p. 029



Poly Gregg
→ p. 030



Rituals + Rituals xl
→ p. 031



Tress
→ p. 032



Twiggy xl
→ p. 033



Uto
→ p. 034



Yoko
→ p. 035



Aplomb
→ p. 038



Birdie
→ p. 039



Caboche
→ p. 040

Terra →

Index



Colibri
→ p. 041



Giga-Lite
→ p. 042



Gregg
→ p. 043



Havana
→ p. 044



Lightwing
→ p. 045



Lumiere xxl
→ p. 046



Magneto
→ p. 047



Mite
→ p. 048



Orbital
→ p. 049



Stewie
→ p. 050



Tress
→ p. 051



Tress Stilo
→ p. 052

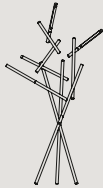

Tuareg
→ p. 053

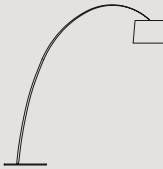

Twiggy
→ p. 054



Twiggy lettura
→ p. 055



Allegretto
→ p. 058



Allegro
→ p. 059



Aplomb
+ Aplomb mini
→ p. 060/061

Sospensione →



Behive
→ p. 062



Big Bang
→ p. 063



Birdie
→ p. 064

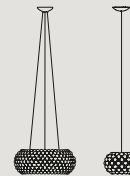

Caboche grande
+ media + piccola
→ p. 065/066/067



Caiigo
→ p. 068

Index



Chouchin
→ p. 069



Chouchin mini
→ p. 070



Chouchin Reverse
→ p. 071



Giga-Lite
→ p. 072



Gregg
→ p. 073



Havana
→ p. 074

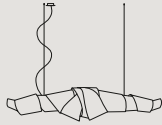

Jamaica
→ p. 075



Le Soleil
→ p. 076

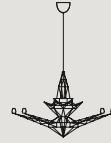

Lightweight
→ p. 077



Maki
→ p. 078



New Buds
→ p. 079



O-space
→ p. 080



Planet
→ p. 081



Plass grande
→ p. 082



Plass media
→ p. 083

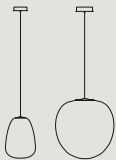

Rituals + Rituals xl
→ p. 084



Spokes
→ p. 086



Supernova
→ p. 087



Tartan
→ p. 088



Tite
→ p. 089



Tress
→ p. 090/91



Tress grande
→ p. 092

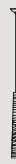

Tress stilo
→ p. 093

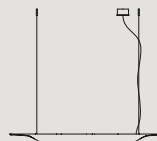

Troag
→ p. 094



Tropico
→ p. 095

Index



Twiggy
→ p. 096



Uto
→ p. 097



Wave
→ p. 098



Soffitto → Bahia + Bahia mini
→ p. 110



Big Bang
→ p. 111

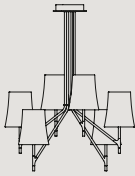

Birdie 1 - 3 - 6 - 9
→ p. 112



Blob S
→ p. 114



Cabocho
→ p. 115



Circus
→ p. 116



Ellepi
→ p. 117

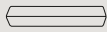

Falena
→ p. 118



Folio
→ p. 119



Gregg
→ p. 120



Lumiere xxl+ xxs
→ p. 121

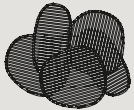

Nuage
→ p. 122



Rituals
→ p. 123



Tivu
→ p. 124



Twiggy
→ p. 125



Parete → Aplobm
→ p. 128



Bahia + Bahia mini
→ p. 129

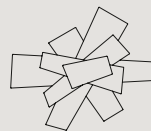

Big Bang
→ p. 130

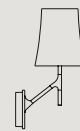

Birdie
→ p. 131

Index



Bit
→ p. 132



Blob S
→ p. 133

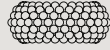

Caboche
→ p. 134



Circus
→ p. 135



Double
→ p. 136



Ellepi
→ p. 137

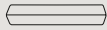

Falena
→ p. 138

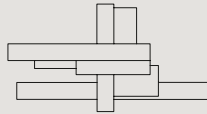

Fields
→ p. 139



Flip
→ p. 140



Folio
→ p. 141



Gregg
→ p. 142



Havana
→ p. 143



Innerlight
→ p. 144



Kite
→ p. 145



Lake
→ p. 146

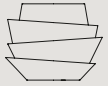

Le Soleil
→ p. 147



Lumiere xxl + xxs
→ p. 148

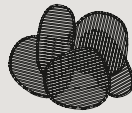

Nuage
→ p. 149



Rituals
→ p. 150

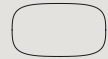

Tivu
→ p. 151



Tress
→ p. 152



Tutù
→ p. 153

Index

Esterno →



Gregg outdoor
sospensione
→ p. 159



Havana outdoor
sospensione
→ p. 160



Gregg outdoor
terra
→ p. 156



Havana outdoor
terra
→ p. 157



Solar outdoor
→ p. 158



Uto
→ p. 161



Rosone
tondo
→ p. 100

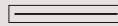

Rosone
lineare L 90
→ p. 100



Rosone
lineare L 135
→ p. 101

Accessori →



Kit
decentramento
→ p. 106



Packing
→ p. 162

Legenda



LED

It marks the models with integrated LED included in the lamp, which is the result of Foscarini designing and engineering.



LED retrofit

It marks the possibility of using a standard retrofit LED bulb available on the market.



ENEC

The label ENEC (Electrical Certification concerning European Standard) is a voluntary label granted by third organizations. It certifies that a product complies with the EN 60598 standards and has been designed and manufactured by companies with an approved UNI EN ISO 9001 quality control system.



Declares that the manufacturer produces light fittings which comply with the requirements of the EN 60598.



Classe I

Class I° luminaire: it's necessary to connect the device to the yellow/green protective conductor (earthing).



Classe II

Light fittings whose safety is guaranteed only by the double and/or reinforced insulation of all parts, with no earth.



Luminaire suitable for installation on normally inflammable surfaces.

IP

IP Protection Degree

IP20: protected against the penetration of solid objects greater than 12 mm and non protected against liquids.

IP44: protected against the penetration of solid objects greater than 1 mm and protected against splashing water.

IP65: dust-tight and protected against water jets.

Energy efficiency classes

The energy efficiency classes for light appliances set out by EU regulation no. 874/2012 are calculated on the basis of the Energy Efficiency Index (EEI) and range between A++ (maximum efficiency) and E (minimum efficiency).

Note:

*

The dimmer could cause flickering of the light in case of use of a bulb with a lower wattage than the minimum indicated. It is not possible to guarantee the proper functioning of the dimmer with LED retrofit bulbs or compact Fluo bulbs with integrated power supply.

Special colours:

it shows the possibility to order the lamps in a different color than the standard one (generally in the lampshade); minimum quantity, price and lead time on request.

Azienda certificata

UNI EN ISO 9001

UNI EN ISO 14001



CSQ - IQNET

The CSQ-IQNET label is valid all over the world. It certifies that Foscarini runs a quality management system which complies with the UNI EN ISO 9001:2008 standard, to guarantee a high quality level for what concerns project, development, production and distribution of its products.



CSQ ECO

This label is valid all over the world. It certifies that Foscarini runs an environmental management system which complies with the UNI EN ISO 14001:2004 standard in order to guarantee company's commitment to continual improvement of its environmental performances.

Excerpt from sales conditions

1. Our prices are net ex works.
2. The prices include: carton packaging, transformers for low tensions. Prices do not include bulbs, if not differently stated.
3. The prices here contained refer to materials complying with the technical standards of the market this price list is meant for. Any request for material complying with other standards shall be quoted separately.
4. Goods are carefully inspected and accurately packed before shipment, Foscarini Spa therefore declines any liability for transport damages.
5. The goods are dispatched at the buyer's risk, even if sent free domicile.
6. Claims must be notified by registered mail addressed to our head offices within 3 days from receipt of the goods.
7. Any litigation falls within cognisance of Venice Italy Law-Court.
8. Dimensions and colours indicated have a tolerance due to the characteristic handwork of blown glass.
9. This price list can be subject to alteration without any notice.
10. Products images and configurations may vary from price book, catalogues and website from the actual merchandise, including but not limited to cords, cables, color, price, dimension, descriptions, details, dimmer.
11. Foscarini reserves the property of the goods until full payment of the same.
12. Prices are expressed in Euro.
13. This price list replaces any previous one.

iFoscarini app



iFoscarini an app designed for all design enthusiasts who wish to customise their surroundings with the unmistakable personality of Foscarini models.

With captivating and emotional graphics and extremely user-friendly it allows users to insert lamps in rooms and settings which are caught on camera each time or picked from an archive of pictures. Available on the Apple Store and Play Store the iFoscarini app is a very effective tool that is extremely simple to use.

Social media

Foscarini is present on all the main social networks with systems and languages suited to each individual channel and type of user:

- **Facebook** to create and maintain public relations, communicate news and projects, share news, images and films;
- **Instagram** to view projects and stimulate users to create images with Foscarini models.
- **Twitter** publicise events, initiatives, news and links in brief, high impact messages;
- **Pinterest** to share images of Foscarini models and initiatives, subdividing them into theme boards;
- **LinkedIn** to create and maintain relationships with sector operators and share professional contents



foscarini.com



Packed with content, the www.foscarini.com website keeps you up-to-date on our products, events and cultural initiatives at all times. The Video Stories section gives you the chance to find out about the concept and development of some of the most important Foscarini products. Information on the company, detailed technical data sheets for all models, assembly instructions, 2D and 3D designs as well as photometric curves can all be downloaded.

myFoscarini



With the same spirit that provides new ideas in lighting design, Foscarini creates its own more efficient programs for customer and partner communication, for instance, **myFoscarini**, a proprietary it platform, an absolutely innovative, highly flexible and transparent tool providing customers with complete information and full range of functions. With just a few clicks in my foscarini you can:

- check the availability of lamps and the shipping date
- Enter your orders, reserving lamps directly from Foscarini's central system

- track your order status
 - consult sale conditions;
 - download admin documents such as transport documents and invoices;
 - prepare a quotation;
 - download: images, logos, PDF and excel price lists assembly instructions, certifications and energy labels.
- And all this 7 days a week, 24 hours a day.
If you haven't registered yet request your password from Foscarini Customer Care.



Tavolo, *Table*014 **Anisha**015 **Behive**018 **Binic**016 **Birdie**017 **Birdie Metal**019 **Caboche**020 **Doll**021 **Esa**022 **Gregg**023 **Kurage**024 - 025 **Lumiere**026 **Lumiere 25th**027 **Lumiere xxi
+ xxs**028 **Magneto**029 **Plass media**030 **Poly Gregg**031 **Rituals**032 **Tress**033 **Twiggy xl**034 **Uto**035 **Yoko**

Anisha

Studio Lievore Altherr
Molina, 2011



	energy cl.	colours	code	vat excluded
<i>Anisha grande</i>	A+	bianco	213001R1 10	353,00
		rosso	213001R1 63	
<i>Anisha piccola</i>	A+	bianco	2130012R1 10	282,00
		rosso	2130012R1 63	

Injection moulded ABS

Anisha grande
LED included
4,5W 3000° K 400 lm
CRI>80 88 lm/W
Touch-dimmer included

Anisha piccola
LED included
3,4W 3000° K 300 lm
CRI>80 88 lm/W
Touch-dimmer included

With personalized packaging



Colours.
bianco, rosso



Special colours
on request

Weight:
Anisha grande
net kg 0,70

Anisha piccola
net kg 0,40

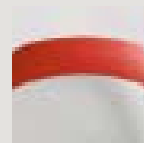
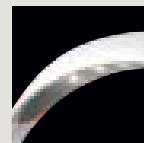
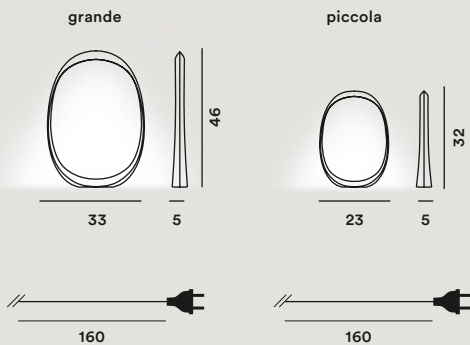

Behive

Werner Aisselinger, 2011



Batch-dyed ABS,
polycarbonate and coated
metal

Halo 1x150W E27
Dimmer included
(minimum bulb output 40W)*

☐ ▽ CE ◀ IP 20

	energy cl.	colours	code	vat excluded
<i>Behive</i>	C	bianco	203001 10	420,00
Spare parts:				
<i>Lampshade Behive</i>		bianco	203S00 10	192,00
<i>Protection glass</i>			203V01/I	50,00
<i>Dimmer</i>			LTD FD TR/I	27,00

Colours: bianco



Special colours
on request

Weight:
net kg 3,70

Halo light bulbs not
included
→ specifications p. 170

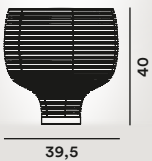

collection →



p. 062



Birdie

Ludovica e Roberto
Palomba, 2011



Polycarbonate, varnished steel and metal

Birdie grande on/off
LED retrofit / Fluo
1x25W E27
Halo 1x150W E27

Birdie grande with touch dimmer
Halo 1x150 E27 (minimum bulb output 40W)*

Birdie piccola on/off
LED retrofit / Fluo
1x20W E27
Halo 1x70W E27

Birdie piccola with touch dimmer
Halo 1x70W E27 (minimum bulb output 40W)*



	energy cl.	colours	code	vat excluded
<i>Birdie grande on/off</i>	A+, A, B, C	bianco	221001S 10	277,00
		grigio	221001S 25	
		arancio	221001S 53	
		amaranto	221001S 65	
<i>Birdie grande with touch dimmer</i>	C	bianco	221001 10	336,00
		grigio	221001 25	
		arancio	221001 53	
		amaranto	221001 65	
<i>Birdie piccola on/off</i>	A+, A, B, C	bianco	2210012 10	235,00
		grigio	2210012 25	
		arancio	2210012 53	
		amaranto	2210012 65	
<i>Birdie piccola with touch dimmer</i>	C	bianco	2210012DM 10	287,00
		grigio	2210012DM 25	
		arancio	2210012DM 53	
		amaranto	2210012DM 65	
Spare parts:				
<i>Lampshade Birdie grande</i>		bianco	221S00 10	66,00
		grigio	221S00 25	
		arancio	221S00 53	
		amaranto	221S00 65	
<i>Lampshade Birdie piccola</i>		bianco	221S002 10	46,00
		grigio	221S002 25	
		arancio	221S002 53	
		amaranto	221S002 65	

Colours: bianco, grigio, arancio, amaranto

Weight:
Birdie grande
net kg 4,00

Halo, Fluo, LED retrofit light bulbs not included
→ specifications p. 170



Birdie piccola
net kg 2,00

Special colours on request

Tecnico — 2016

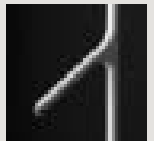
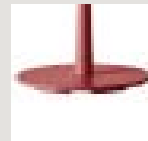
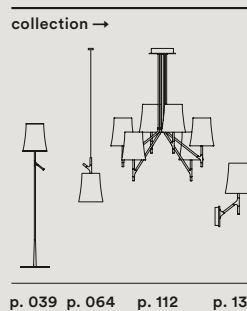
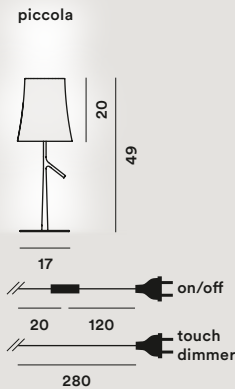
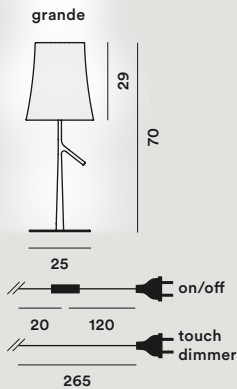

Birdie Metal

Ludovica e Roberto
Palomba, 2011



	energy cl.	colours	code	vat excluded
<i>Birdie Metal grande</i>	A+, A	cromo nero	221001S 78	416,00
		rame	221001S 57	
<i>Birdie Metal piccola</i>	A+, A	cromo nero	2210012 78	324,00
		rame	2210012 57	
Spare parts:				
<i>Lampshade Birdie Metal grande</i>		cromo nero	221S00 78	84,00
		rame	221S00 57	
<i>Lampshade Birdie Metal piccola</i>		cromo nero	221S002 78	59,00
		rame	221S002 57	

Metallized polycarbonate
and metallized steel

Birdie Metal grande
LED retrofit / Fluo
1x25W E27

Birdie Metal piccola
LED retrofit / Fluo
1x20W E27

With personalized packaging

IP 20

Colours:
cromo nero, rame



Weight:
Birdie Metal grande
net kg 4,00

Birdie Metal piccola
net kg 2,00

Fluo, LED retrofit light
bulbs not included
→ specifications p. 170

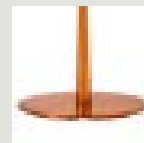
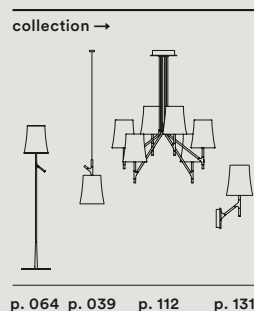
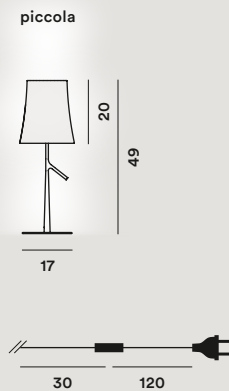
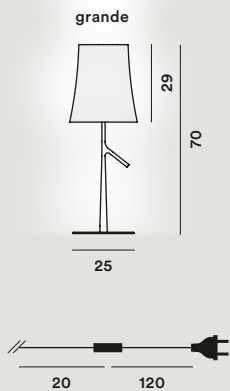

018 Tavolo, Table

Binic

Ionna Vautrin, 2010



	energy cl.	colours	code	vat excluded
<i>Binic</i>	A+, A	bianco	20000110	122,00
		antracite	20000127	
		verde acqua	20000142	
		giallo	20000155	
		rosa	20000161	
		blu	20000187	

batch-dyed ABS and polycarbonate

LED retrofit / Fluo
1x12W E 14

With personalized packaging

☐ ▽ CE IP 20

Colours: bianco, rosa, verde acqua, blu, giallo, antracite

Weight:
net kg 0,60

Fluo, LED retrofit light bulbs not included
→ specifications p. 170

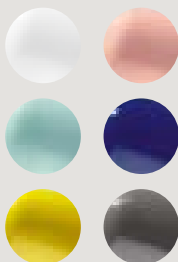

Tecnico — 2016

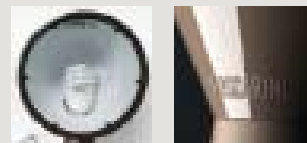
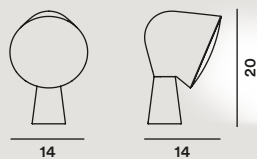

Caboche

Patricia Urquiola e
Elia Gerotto, 2005



PMMA, blown glass and
coated aluminium

Halo 1x48W G9
Dimmer included
(minimum bulb output
40W)*

☐ ▽ CE IP 20

	energy cl.	colours	code	vat excluded
Caboche	C	trasparente	138012 16	504,00
		giallo oro	138012 52	
Spare parts:				
Set sphere Caboche tavolo		trasparente	138S002 16	160,00
		giallo oro	138S002 52	
Kit 10 prongs 3 sphere Caboche tavolo			138KIT 10P3	23,00
Kit 10 prongs 4 sphere Caboche tavolo			138KIT 10P4	23,00
Kit 3+3 prongs 3 + 4 sphere Caboche tavolo			138KIT2-R2	18,00
Glass Caboche tavolo			138V012/I	39,00
Dimmer			LTD FD TR/I	27,00

Colours:
trasparente, giallo oro

Weight:
net kg 5,30

Halo light bulbs not
included
→ specifications p. 170

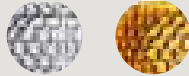

Special colours
on request

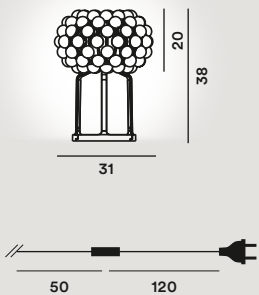

collection →

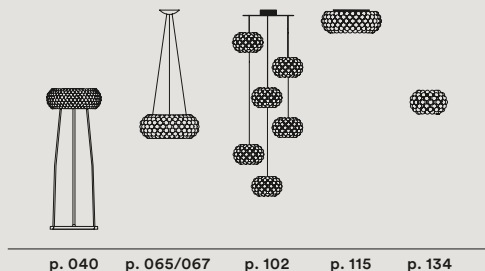

p. 040 p. 065/067 p. 102 p. 115 p. 134



020 Tavolo, Table

Doll

Ionna Vautrin, 2012



	energy cl.	colours	code	vat excluded
<i>Doll</i>	A+, A	grigio	245001 25	134,00
		verde	245001 40	
		avorio	245001 50	
		rosso	245001 63	

Spare parts:

<i>Glass Doll</i>		245S00 10	61,00
-------------------	--	-----------	-------

Blown glass, batch-dyed
ABS and polycarbonate

LED retrofit / Fluo
1x12W E14

With personalized packaging

☐ ▽ CE IP 20

Colours: avorio, grigio,
verde, rosso

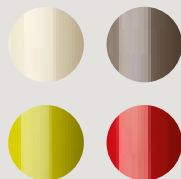

Weight:
net kg 0,70

Fluo, LED retrofit light
bulbs not included
→ specifications p. 170

Tecnico — 2016

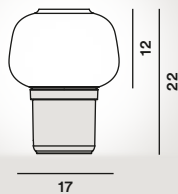

Esa

Studio Lievore Altherr
Molina, 1996



Blown glass and polished
aluminium

Esa grande
LED retrofit / Fluo
1x20W E27
Halo 1x77W E27

Esa piccola
Halo 1x33W G9
Dimmer included
(minimum bulb output 10W)*

☐ ▽ CE IP 20

	energy cl.	colours	code	vat excluded
<i>Esa grande</i>	A ⁺ , A, B, C	bianco	075001-R2 11	585,00
<i>Esa piccola</i>	C	bianco	0750012 11	329,00

Spare parts:

<i>Glass Esa grande</i>	bianco	075S00 11	267,00
<i>Glass Esa piccola</i>	bianco	075S002 11	146,00
<i>Dimmer Esa piccola</i>		LTD 1002/I	39,00

Colours: bianco



Special colours
on request

Weight:
Esa grande
net kg 3,20

Esa piccola
net kg 2,30

Halo, Fluo, LED retrofit
light bulbs not included
→ specifications p. 170

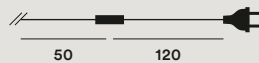
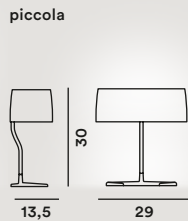
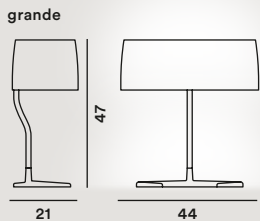

Gregg

Ludovica e Roberto
Palomba, 2007



Blown acid-etched glass and coated metal

Gregg grande
Led retrofit / Fluo 1x25W E27
Halo 1x205W E27
Dimmer included (minimum bulb output 60W)*

Gregg media
Led retrofit / Fluo 1x20W E27
Halo 1x150W E27
Dimmer included (minimum bulb output 40W)*

Gregg piccola
Halo 1x20W G9
Dimmer included (minimum bulb output 10W)*



grande

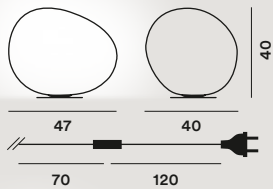

media

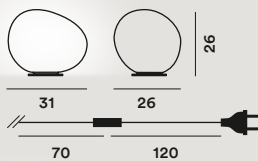

piccola

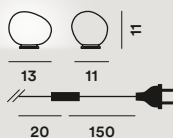

	energy cl.	colours	code	vat excluded
<i>Gregg grande on/off</i>	A+, A, B, C	bianco	1680011S 10	507,00
<i>Gregg grande w. dimmer</i>	C		1680011 10	526,00
<i>Gregg media on/off</i>	A+, A, B, C	bianco	168001S 10	300,00
<i>Gregg media w. dimmer</i>	C		168001 10	319,00
<i>Gregg piccola on/off</i>	A+, A, B, C	bianco	1680012S 10	145,00
<i>Gregg piccola w. dimmer</i>	C		1680012 10	175,00

Spare parts:

<i>Glass Gregg grande</i>	bianco	168S001 10	318,00
<i>Dimmer</i>		LTD RONDO T/I	39,00
<i>Glass Gregg media</i>	bianco	168S00 10	172,00
<i>Dimmer</i>		LTD FD TR/I	27,00
<i>Glass Gregg piccola</i>	bianco	168S00210	59,00
<i>Dimmer</i>		LTD 1002/I	39,00

Colours: bianco



Special colours
on request

Weight:
Gregg grande
net kg 6,80

Gregg media
net kg 3,30

Gregg piccola
net kg 0,60

Halo, Fluo, LED retrofit
light bulbs not included
→ specifications p. 170

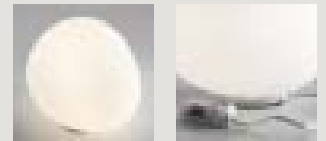
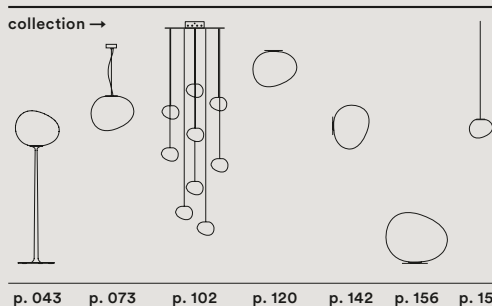

Kurage

Nichetto + Nendo, 2015



	energy cl.	colours	code	vat excluded
Kurage	A+, A	bianco	258001 10	420,00

Washi paper and ashwood

Colours: bianco

Weight:
net kg 0,70Fluo, LED retrofit light
bulbs not included
→ specifications p. 170LED retrofit / Fluo
1x12W E27

IP 20

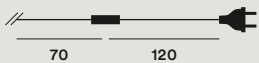
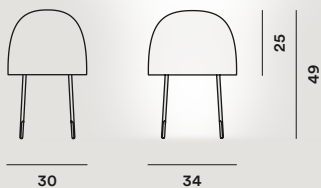

Lumiere grande

Rodolfo Dordoni, 1990



Blown glass and polished aluminium or black chrome

Halo 2x48W G9
(minimum total bulb output
40W with dimmer)*



	energy cl.	colours	code	vat excluded
Lumiere grande on/off	A+, A, B, C	alluminio/bianco	026001R2 11	429,00
		all./bianco caldo	026001R2 12	475,00
		all./turchese	026001R2 32	475,00
		all./ciliegia	026001R2 62	475,00
Lumiere grande on/off	A+, A, B, C	cromo nero/bianco	026011R2 11	429,00
		c. nero/bianco caldo	026011R2 12	475,00
		c. nero/turchese	026011R2 32	475,00
		c. nero/ciliegia	026011R2 62	475,00
Lumiere grande on/off	A+, A, B, C	champagne/bianco	026021R2 11	429,00
		cham./bianco caldo	026021R2 12	475,00
		cham./turchese	026021R2 32	475,00
		cham./ciliegia	026021R2 62	475,00
Lumiere grande with dimmer	C	alluminio/bianco	026001R2 11 D	458,00
		all./bianco caldo	026001R2 12 D	504,00
		all./turchese	026001R2 32 D	504,00
		all./ciliegia	026001R2 62 D	504,00
Lumiere grande with dimmer	C	cromo nero/bianco	026011R2 11 D	458,00
		c. nero/bianco caldo	026011R2 12 D	504,00
		c. nero/turchese	026011R2 32 D	504,00
		c. nero/ciliegia	026011R2 62 D	504,00
Lumiere grande with dimmer	C	champagne/bianco	026021R2 11 D	458,00
		cham./bianco caldo	026021R2 12 D	504,00
		cham./turchese	026021R2 32 D	504,00
		cham./ciliegia	026021R2 62 D	504,00

Spare parts:

Glass Lumiere grande	bianco	026S00 11	181,00
	bianco caldo	026S00 12	227,00
	turchese	026S00 32	227,00
	ciliegia	026S00 62	227,00
Dimmer		LTD FD TR/I	27,00

Glass colours: bianco, bianco caldo, ciliegia, turchese

Weight: net kg 2,40

Halo light bulbs not included
→ specifications p. 170

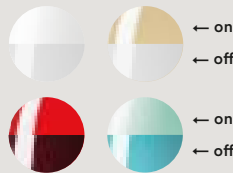

Frame colours: alluminio, cromo nero, champagne

collection →

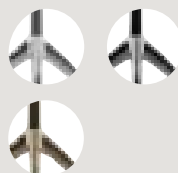

Special colours on request



p. 026

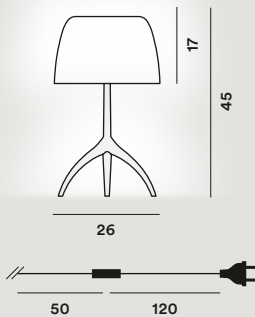
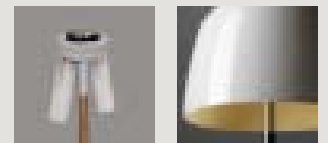

Lumiere piccola

Rodolfo Dordoni, 1990



Blown glass and polished
aluminium or varnished

Halo 1x42W G9
(minimum total bulb output
40W with dimmer)*

□ ▽ CE ◀ IP 20

	energy cl.	colours	code	vat excluded
Lumiere piccola on/off	A ⁺ , A, B, C	alluminio/bianco	0260012R2 11	294,00
		all./bianco caldo	0260012R2 12	332,00
		all./turchese	0260012R2 32	332,00
		all./ciliegia	0260012R2 62	332,00
Lumiere piccola on/off	A ⁺ , A, B, C	cromo nero/bianco	0260112R2 11	294,00
		c. nero/bianco caldo	0260112R2 12	332,00
		c. nero/turchese	0260112R2 32	332,00
		c. nero/ciliegia	0260112R2 62	332,00
Lumiere piccola on/off	A ⁺ , A, B, C	champagne/bianco	0260212R2 11	294,00
		cham./bianco caldo	0260212R2 12	332,00
		cham./turchese	0260212R2 32	332,00
		cham./ciliegia	0260212R2 62	332,00
Lumiere piccola with dimmer	C	alluminio/bianco	0260012R2 11D	323,00
		all./bianco caldo	0260012R2 12D	361,00
		all./turchese	0260012R2 32D	361,00
		all./ciliegia	0260012R2 62D	361,00
Lumiere piccola with dimmer	C	cromo nero/bianco	0260112R2 11D	323,00
		c. nero/bianco caldo	0260112R2 12D	361,00
		c. nero/turchese	0260112R2 32D	361,00
		c. nero/ciliegia	0260112R2 62D	361,00
Lumiere piccola with dimmer	C	champagne/bianco	0260212R2 11D	323,00
		cham./bianco caldo	0260212R2 12D	361,00
		cham./turchese	0260212R2 32D	361,00
		cham./ciliegia	0260212R2 62D	361,00
Spare parts:				
Glass Lumiere piccola		bianco	026S002R 11	103,00
		bianco caldo	026S002R 12	141,00
		turchese	026S002R 32	141,00
		ciliegia	026S002R 62	141,00
Dimmer			LTD FD TR/I	27,00

Glass colours: bianco, bianco caldo, ciliegia, turchese

Weight:
net kg 1,11

Halo light bulbs not
included
→ specifications p. 170

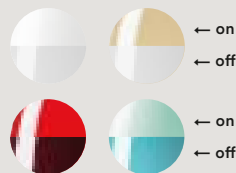

Frame colours:
alluminio, cromo nero,
champagne

collection →

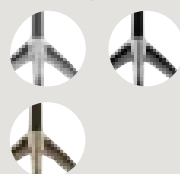

Special colours
on request



p. 026

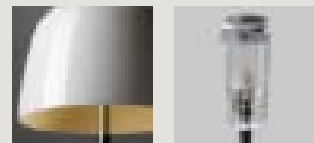
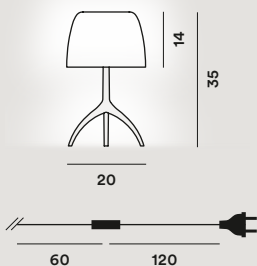

Lumiere 25th

Rodolfo Dordoni,
1990/2015



Blown mirrored glass and polished or varnished aluminium

Lumiere 25th grande
Halo 2x48W G9
(minimum total bulb output 40W with dimmer)*

Lumiere 25th piccola
Halo 1x42W G9
(minimum total bulb output 40W with dimmer)*

IP 20

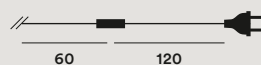
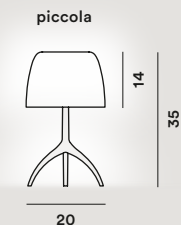
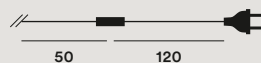
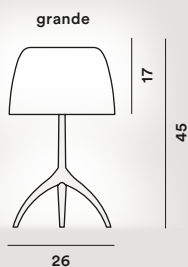

	energy cl.	colours	code	vat excluded
<i>Lumiere 25th grande</i>	A ⁺ , A, B, C	alluminio/25 th	026001R2 30	588,00
		cromo nero/25 th	026011R2 30	
		champagne/25 th	026021R2 30	
<i>Lumiere 25th grande with dimmer</i>	C	alluminio/25 th	026001R2 30 D	617,00
		cromo nero/25 th	026011R2 30 D	
		champagne/25 th	026021R2 30 D	
<i>Lumiere 25th piccola</i>	A ⁺ , A, B, C	alluminio/25 th	0260012R2 30	445,00
		cromo nero/25 th	0260112R2 30	
		champagne/25 th	0260212R2 30	
<i>Lumiere 25th piccola with dimmer</i>	C	alluminio/25 th	0260012R2 30D	474,00
		cromo nero/25 th	0260112R2 30D	
		champagne/25 th	0260212R2 30D	

Spare parts:

<i>glass Lumiere 25th grande</i>	026S00 30	340,00
<i>glass Lumiere 25th piccola</i>	026S002R 30	254,00

Glass colours:
specchio trasparente



Weight:
Lumiere 25th grande
net kg 2,40

Lumiere 25th piccola
net kg 1,11

Halo light bulbs not included
→ specifications p. 170

Frame colours:
alluminio, cromo nero,
champagne



collection →

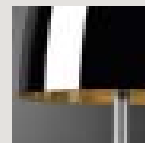

Lumiere xxl + xxs

Rodolfo Dordoni, 2009



Blown glass and lacquered aluminium

Lumiere xxl
Halo 4x33W G9
Dimmer included

Lumiere xxs
Halo 1x48W G9
Dimmer included (minimum bulb output 40W)*

□ ▽ CE IP 20

Lumiere xxl

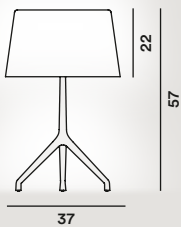

Lumiere xxs

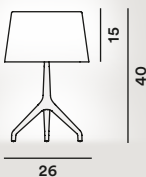

	energy cl.	colours	code	vat excluded
Lumiere xxl	C	alluminio/bianco	191001A 11	748,00
		alluminio/grigio	191001A 24	
		alluminio/marrone	191001A 55	
		cromo nero/bianco	191001C 11	
		cromo nero/grigio	191001C 24	
		cr. nero/marrone	191001C 55	
Lumiere xxs	C	alluminio/bianco	1910012A 11	491,00
		alluminio/grigio	1910012A 24	
		alluminio/marrone	1910012A 55	
		cromo nero/bianco	1910012C 11	
		cromo nero/grigio	1910012C 24	
		cr. nero/marrone	1910012C 55	

Spare parts:

Glass Lumiere xxl	bianco	191S001 11	335,00
	grigio	191S001 24	
	marrone	191S001 55	
Glass Lumiere xxs	bianco	191S002 11	204,00
	grigio	191S002 24	
	marrone	191S002 55	
Dimmer		LTD FD TR/I	27,00

Glass colours: bianco, grigio freddo, marrone freddo

Weight: **Lumiere xxl**
net kg 5,50

Halo light bulbs not included
→ specifications p. 170



Lumiere xxs
net kg 1,80



Frame colours:
alluminio, cromo nero



Special colours
on request

collection →

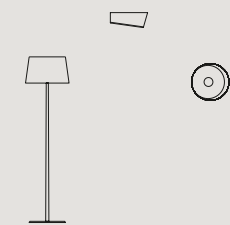

p. 046 p. 121 p. 148



028 Tavolo, Table

Magneto

Giulio Iacchetti, 2011



	energy cl.	colours	code	vat excluded
<i>Magneto</i>	A+	bianco	202001R2 10	301,00
		nero	202001R2 20	

Coated steel, ABS and super magnet made of "rare earth"

Colours:
bianco, nero

Weight:
net kg 1,30

LED included
5W 2700° K 475 lm
CRI>80 95 lm/W



Special colours
on request

With personalized packaging



Tecnico — 2016

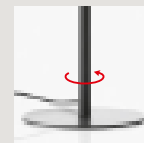
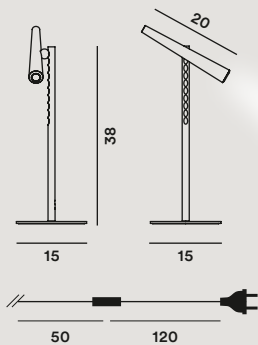

Plass media

Luca Nichetto, 2015



Rotational moulded
polycarbonate and steel

Plass media on/off
LED retrofit / Fluo
1x25W E27

Halo 1x150W E27

Plass media with dimmer
Halo 1x150W E27 (minimum
bulb output 40W)*

□ ▽ CE ◀ IP 20

	energy cl.	colours	code	vat excluded
<i>Plass media on/off</i>	A ⁺ , A, B, C	grigio	2240012 25	350,00
		azzurro	2240012 30	
<i>Plass media with dimmer</i>	C	grigio	2240012D 25	370,00
		azzurro	2240012D 30	
Spare parts:				
<i>Lampshade Plass</i>		grigio	224S002 25	222,00
		azzurro	224S002 30	
<i>Dimmer</i>			LTD FD TR/I	27,00

Colours:
grigio, azzurro

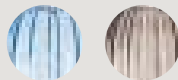

Special colours
on request

Weight:
net kg 4,00

Halo, Fluo, LED retrofit
light bulbs not included
→ specifications p. 170

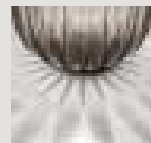
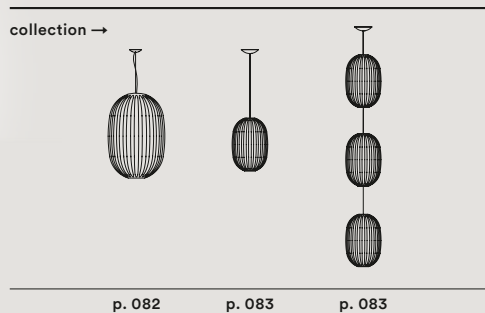
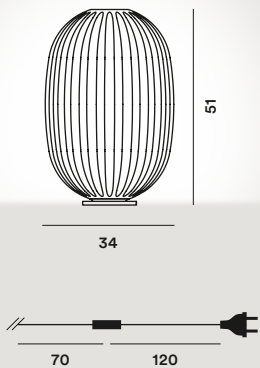

Poly Gregg

Ludovica e Roberto
Palomba, 2011



	energy cl.	colours	code	vat excluded
<i>Poly Gregg X-large</i>	A ⁺ , A	bianco	2180030 10	353,00
<i>Poly Gregg grande</i>	A ⁺ , A	bianco	2180130 10	275,00
<i>Poly Gregg media</i>	A ⁺ , A	bianco	2180230 10	193,00

Spare parts:

<i>Lampshade Poly Gregg X-large</i>	bianco	218S001 10	179,00
<i>Lampshade Poly Gregg grande</i>	bianco	218S00 10	101,00
<i>Lampshade Poly Gregg media</i>	bianco	218S002 10	63,00

Rotational moulded
polyethylene

Poly Gregg X-large / grande
LED retrofit / Fluo
1x25W E27

Poly Gregg media
LED retrofit / Fluo
1x15W E27



Colours: bianco



Weight:
X-large
net kg 4,30

grande
net kg 3,60

media
net kg 1,60

Fluo, LED retrofit light
bulbs not included
→ specifications p. 170

X-large

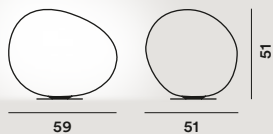

grande

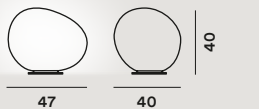

media

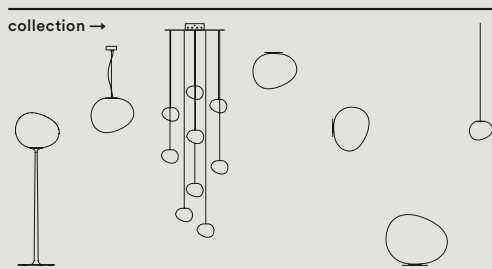
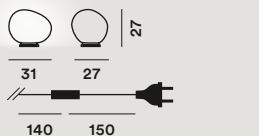

p. 043 p. 076 p. 102 p. 120 p. 142 p. 156 p. 159

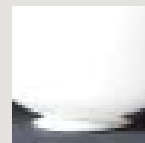

Rituals + Rituals xl

Ludovica e Roberto
Palomba, 2012 - 2015



Blown engraved satin glass
and coated metal

1-2-3 on/off

LED retrofit / Fluo 1x15W E27
Halo 1x105W E27

1-2-3 with dimmer

Halo 1x60W G9 (minimum
bulb output 40W)*

Rituals xl on/off

LED retrofit / Fluo 1x25W E27
Halo 1x150W E27

Rituals xl with dimmer

Halo 1x150W E27 (minimum
bulb output 40W)*

IP 20

	energy cl.	colours	code	vat excluded
<i>Rituals 1 on/off</i>	A ⁺ , A, B, C	bianco	2440011 10	335,00
<i>Rituals 1 with dimmer</i>	C	bianco	2440011D 10	373,00
<i>Rituals 2 on/off</i>	A ⁺ , A, B, C	bianco	2440012 10	335,00
<i>Rituals 2 with dimmer</i>	C	bianco	2440012D 10	373,00
<i>Rituals 3 on/off</i>	A ⁺ , A, B, C	bianco	2440013 10	280,00
<i>Rituals 3 with dimmer</i>	C	bianco	2440013D 10	318,00
<i>Rituals xl on/off</i>	A ⁺ , A, B, C	bianco	2440014 10	487,00
<i>Rituals xl with dimmer</i>	C	bianco	2440014D 10	506,00

Spare parts:

<i>Glass Rituals 1</i>	bianco	244S001 10	222,00
<i>Glass Rituals 2</i>	bianco	244S002 10	222,00
<i>Glass Rituals 3</i>	bianco	244S003 10	167,00
<i>Glass Rituals XL</i>	bianco	244S004 10	315,00
<i>Dimmer</i>		LTD FD TR/1	27,00
<i>Halogen protection glass</i>		PIREX 80-28/3	5,00

Colours: bianco



Weight:

Rituals 1
net kg 4,00

Rituals 2
net kg 4,10

Rituals 3
net kg 1,60

Rituals xl
net kg 7,20

Halo, Fluo, LED retrofit
light bulbs not included
→ specifications p. 170

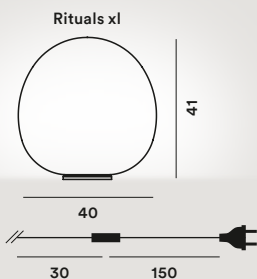
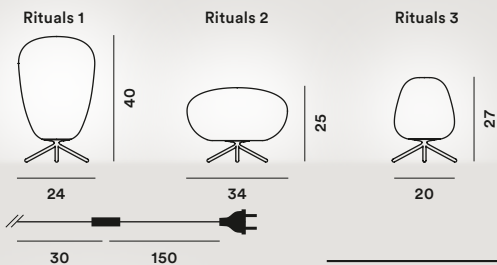

collection →

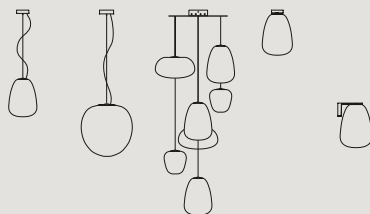

p. 084 p. 084 p. 102 p. 123 p. 150



032 Tavolo, Table

Tress

Marc Sadler, 2009

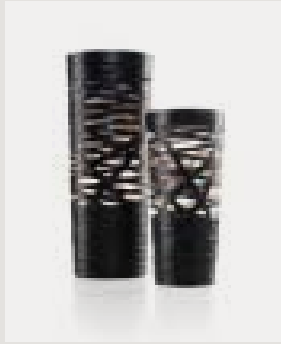

Varnished fibreglass-based composite material

Tress
Halo 1x100W E27 PAR 30
dimmer included

Tress mini
Halo 1x75W GU10 PAR 20
Dimmer included
(minimum bulb output
40W)*

☐ ⚡ CE IP 20

	energy cl.	colours	code	vat excluded
Tress	C	bianco	182001 10	436,00
		nero	182001 20	
		cremisi	182001 67	
		greige	182001 25	
		indaco	182001 87	
Tress mini	C	bianco	1820012 10	391,00
		nero	1820012 20	
		cremisi	1820012 67	
		greige	1820012 25	
		indaco	1820012 87	
Spare parts:				
Lampshade Tress		bianco	182S01 10	303,00
		nero	182S01 20	
		cremisi	182S01 67	
		greige	182S01 25	
Lampshade Tress mini		indaco	182S01 87	280,00
		bianco	182S0012 10	
		nero	182S0012 20	
		cremisi	182S0012 67	
		greige	182S0012 25	27,00
		indaco	182S0012 87	
		Dimmer	LTD FD TR/I	

Colours: bianco, nero,
rosso, greige, indaco

Weight:
Tress
net kg 3,20

Halo light bulbs not
included
→ specifications p. 170

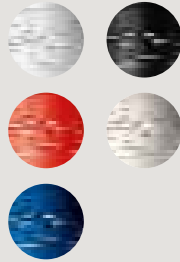

Tress mini
net kg 1,40

Special colours
on request

Tress
23



20

Tress mini

20



16

collection →

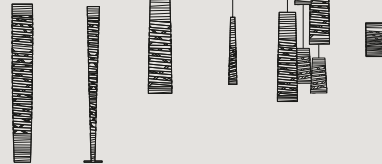

p. 051 p. 052 p. 090 p. 093 p. 102 p. 152



50 150 40 150



Twiggy xl

Marc Sadler, 2008



	energy cl.	colours	code	vat excluded
<i>Twiggy xl</i>	C	bianco	1590011 10	739,00
		nero	1590011 20	

Spare parts:

<i>Lampshade Twiggy xl</i>	bianco	159S10 10	464,00
	nero	159S10 20	
<i>Dimmer</i>		LTD 5000TR/I	37,00

Varnished fibreglass-based composite material, polycarbonate and varnished metal

Colours:
bianco, nero



Special colours
on request

Weight:
net kg 6,80

Halo light bulbs not
included
→ specifications p. 170

Halo 3x77W E27
Dimmer included (minimum
total bulb output 60W)*

☐ ▽ CE IP 20

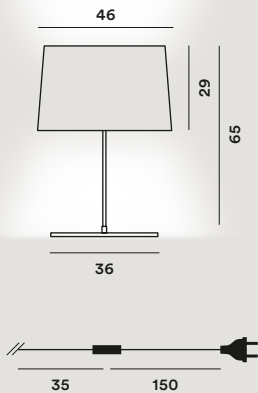

collection →

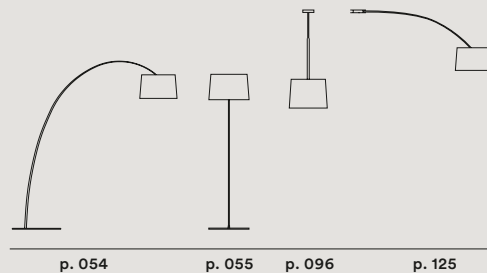

Uto

Lagranja Design, 2005



	energy cl.	colours	code	vat excluded
<i>Uto</i>	A ⁺ , A	bianco	142000 10	319,00
		giallo	142000 50	
		arancio	142000 53	

Thermoplastic elastomer and polycarbonate

LED retrofit / Fluo
1x15W E27

Switch inside the flexible tube

IP 44

Colours: bianco, giallo, arancio

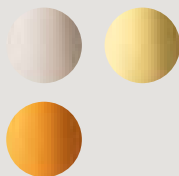

Weight:
net kg 2,00

Fluo, LED retrofit light bulbs not included
→ specifications p. 170

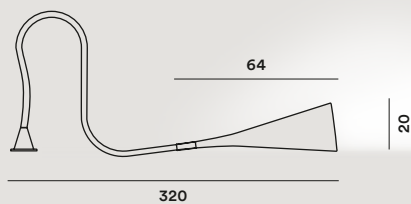

Yoko

Anderssen & Voll, 2013



	energy cl.	colours	code	vat excluded
Yoko	A ⁺ , A	verde	239001 40	259,00
		arancio	239001 50	
		viola	239001 80	

Spare parts:

Lampshade Yoko	verde	239S00 40	134,00
	arancio	239S00 50	
	viola	239S00 80	

PMMA / polycarbonate

LED retrofit / Fluo
1x25W E27

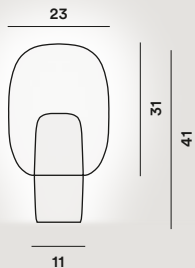
Colours: verde,
arancio, violaWeight:
net kg 2,00Fluo, LED retrofit light
bulbs not included
→ specifications p. 170



Terra, *Floor*

- | | | | |
|-----|---------------------------|-----|------------------------------|
| 038 | Aplomb | 047 | Magneto |
| 039 | Birdie | 048 | Mite |
| 040 | Caboche | 049 | Orbital |
| 041 | Colibrì | 050 | Stewie |
| 042 | Giga-Lite | 051 | Tress |
| 043 | Gregg | 052 | Tress Stilo |
| 044 | Havana | 053 | Tuareg |
| 045 | Lightwing | 054 | Twiggy |
| 046 | Lumiere <i>xxl</i> | 055 | Twiggy <i>lettura</i> |

Aplomb

Lucidi e Pevere, 2013



	energy cl.	colours	code	vat excluded
<i>Aplomb terra</i>	C	bianco	195003 10	609,00
		grigio	195003 25	
		marrone	195003 52	
Spare parts:				
<i>Dimmer</i>			LTD RONDO T/I	39,00

Concrete and coated metal

Halo 1x120W R7s
Dimmer included (minimum
bulb output 60W)*

Colours:
bianco, grigio cemento,
marrone

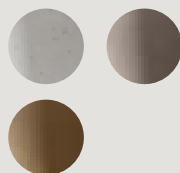

Weight:
net kg 8,50

Halo light bulbs not
included
→ specifications p. 170

Tecnico — 2016

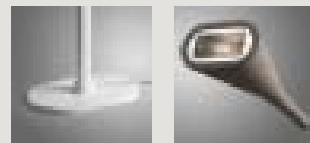
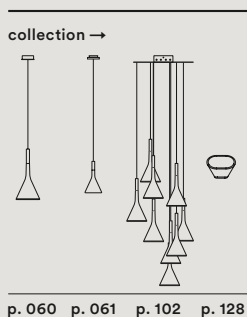
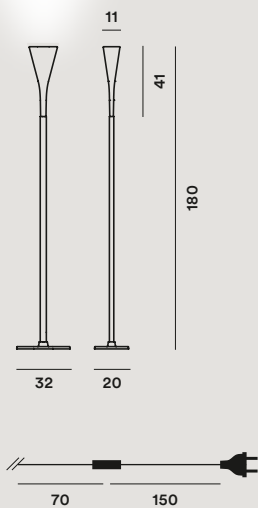

Birdie

Ludovica e Roberto
Palomba, 2011



Polycarbonate, coated steel
and metal

Birdie lettura on/off
LED retrofit / Fluo
1x25W E27
Halo 1x150W E27

*Birdie lettura with touch
dimmer*
Halo 1x150W E27 (minimum
bulb output 40W)*

IP 20

	energy cl.	colours	code	vat excluded
<i>Birdie lettura on/off</i>	A ⁺ , A, B, C	bianco	221004S 10	311,00
		grigio	221004S 25	
		arancio	221004S 53	
		amaranto	221004S 65	
<i>Birdie lettura with touch dimmer</i>	C	bianco	221004 10	370,00
		grigio	221004 25	
		arancio	221004 53	
		amaranto	221004 65	
Spare parts:				
<i>Lampshade Birdie</i>		bianco	221S00 10	66,00
		grigio	221S00 25	
		arancio	221S00 53	
		amaranto	221S00 65	

Colours: bianco, grigio,
arancio, amaranto

Weight:
net kg 4,30

Halo, Fluo, LED retrofit
light bulbs not included
→ specifications p. 170



Special colours
on request

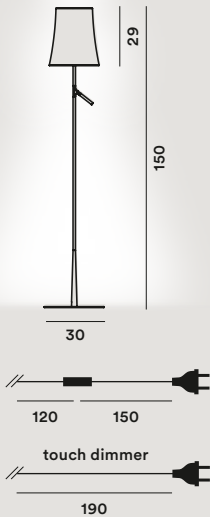

collection →

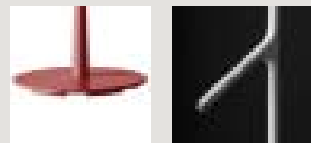
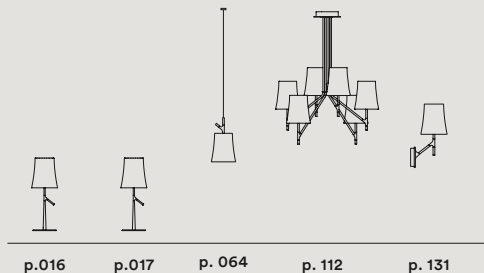

Caboche

Patricia Urquiola
e Eliana Gerotto, 2005



Polymethylmethacrylate,
blown glass and white
lacquered metal

Caboche grande
Halo 1x230W R7s
Dimmer included

Caboche media
Halo 1x160W R7s
Dimmer included (minimum
bulb output 60W)*

☐ ▽ CE IP 20

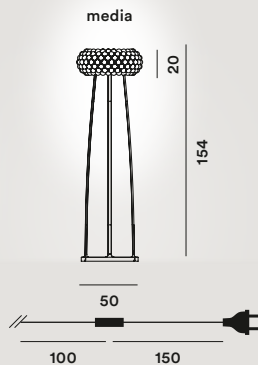
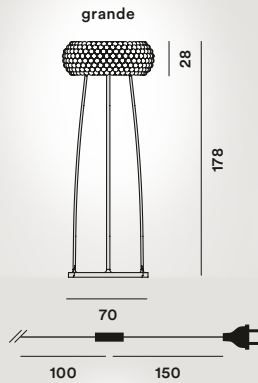

	energy cl.	colours	code	vat excluded
Caboche grande	C	trasparente	138013 16	1.672,00
		giallo oro	138013 52	
Caboche media	C	trasparente	138003 16	1.078,00
		giallo oro	138003 52	

Spare parts:

Set sphere Caboche grande	trasparente	138S001 16	599,00
	giallo oro	138S001 52	
Kit 20 prongs 4 sphere Caboche grande		138KIT 20G4	34,00
Kit 20 prongs 5 sphere Caboche grande		138KIT 20G5	34,00
Kit 3+3 prongs 4 + 5 sphere Caboche grande		138KIT1-R2	18,00
Set sphere Caboche media	trasparente	138S00 16	322,00
	giallo oro	138S00 52	
Kit 15 prongs 3 sphere Caboche media		138KIT 15M3	26,00
Kit 15 prongs 4 sphere Caboche media		138KIT 15M4	26,00
Kit 3+3 prongs 3 + 4 sphere Caboche media		138KIT-R2	19,00
Glass Caboche grande		138V011/I	117,00
Glass Caboche media		138V01R1/I	72,00
Halogen protection glass		PIREX138/2S4I	18,00
Halo. protection disk Caboche grande		138V021/I	44,00
Halo. protection disk Caboche media		138V02/I	37,00
Dimmer		LTD RONDO T/I	39,00

Colours:
trasparente, giallo oro

Weight:
Caboche grande
net kg 23,90

Halo light bulbs not
included
→ specifications p. 170

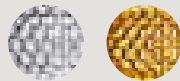

Caboche media
net kg 11,80

Special colours
on request

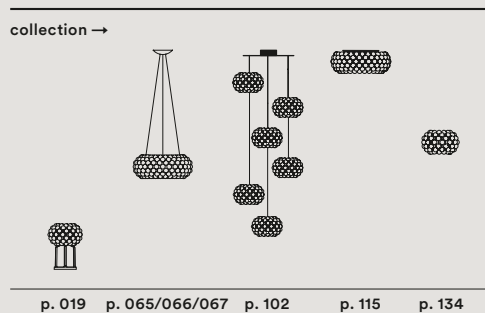

041

Colibri

Odoardo Fioravanti, 2011



	energy cl.	colours	code	vat excluded
<i>Colibri</i>	C	bianco	222004 10	452,00
Spare parts:				
<i>Dimmer</i>			LTD RT81 T/I	29,00

Polycarbonate, coated aluminium and metal

Halo 1x75W GU10 PAR 20
Dimmer included
(minimum bulb output
60W)*

Adjustable lampshade on the
vertical and horizontal axis

☐ ▽ CE IP 20

Colours: bianco



Special colours
on request

Weight:
net kg 5,10

Halo light bulbs not
included
→ specifications p. 170

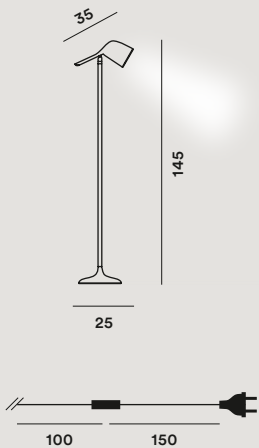

Giga-Lite

Marc Sadler, 2004



Fiberglass fabric, carbonium thread and stainless steel

Extendable

Halo 3x100W E27
Dimmer included (minimum total bulb output 60W)*

☐ ▽ CE IP 20

	energy cl.	colours	code	vat excluded
<i>Giga-Lite</i>	C	nero	139013 20	916,00
Spare parts:				
<i>Lampshade Giga-Lite</i>		nero	139S001 20	371,00
<i>Dimmer</i>			LTD RONDO T/I	39,00

Colours: nero



Weight:
net kg 9,80

Halo light bulbs not included
→ specifications p. 170

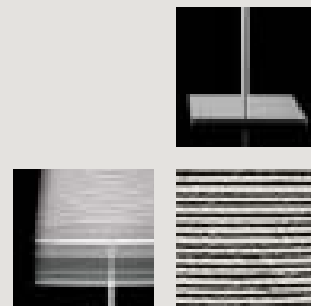
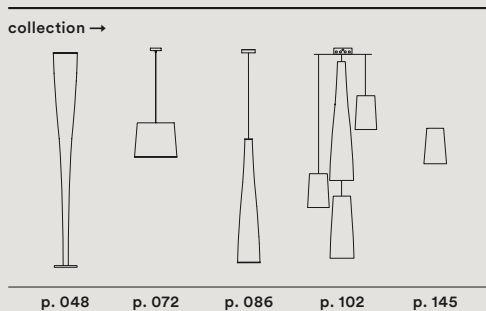
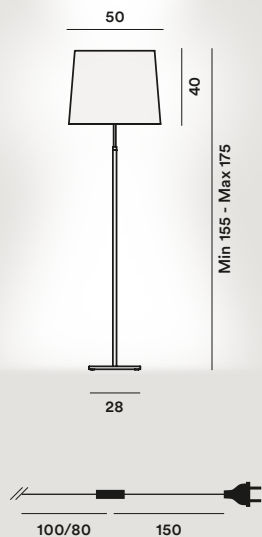

Gregg

Ludovica e Roberto
Palomba, 2010



Blown acid-etched glass,
lacquered polyurethane and
metal

Halo 1x205W E27
Dimmer included (minimum
bulb output 60W)*

☐ ▽ CE IP 20

	energy cl.	colours	code	vat excluded
<i>Gregg grande</i>	C	bianco	168013A 10	817,00
<i>Gregg media</i>	C	bianco	168003A 10	671,00
Spare parts:				
<i>Glass Gregg grande</i>		bianco	168S0031 10	318,00
<i>Dimmer</i>			LTD RONDO T/I	39,00
<i>Glass Gregg media</i>		bianco	168S00 10	172,00
<i>Dimmer</i>			LTD RONDO T/I	39,00

Colours: bianco



Special colours
on request

Weight:
grande
net kg 14,70

media
net kg 11,70

Halo light bulbs not
included
→ specifications p. 170

grande

47

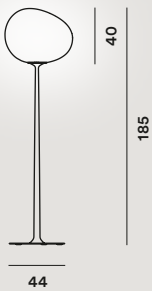

media

31

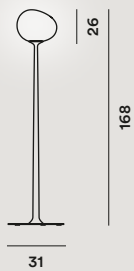

collection →

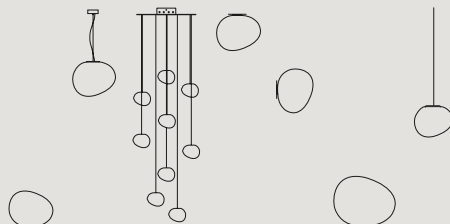

p. 022 p. 073 p. 102 p. 120 p. 142 p. 156 p. 159



130 150

Havana

Joseph Forakis, 1993



	energy cl.	colours	code	vat excluded
<i>Havana on/off</i>	A ⁺ , A, B, C	allum./bianco	040003 10	290,00
<i>Havana on/off</i>	A ⁺ , A, B, C	cromo/bianco	040003C 10	345,00
<i>Havana with dimmer</i>	C	allum./bianco	040003 10 D	313,00
<i>Havana with dimmer</i>	C	cromo/bianco	040003C 10 D	368,00

Spare parts:

<i>Set lampshades Havana</i>	bianco	040S00 10	79,00
<i>Dimmer</i>		LTD 5000TR/I	37,00

Injection moulded polyethylene and coated or chromed metal

Havana on/off
LED retrofit / Fluo
1x25W E27
Halo 1x116W E27

Havana with dimmer
Halo 1x116W E27
(minimum bulb output 60W)*

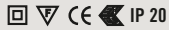

Lampshade:
bianco



Frame:
alluminio, cromo



Special colours
on request

Weight:
net kg 3,30

Halo, Fluo, LED retrofit
light bulbs not included
→ specifications p. 170

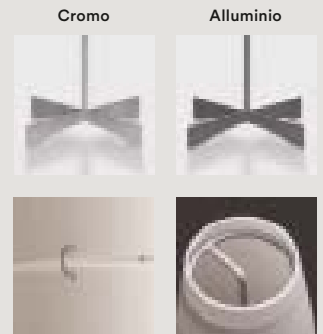
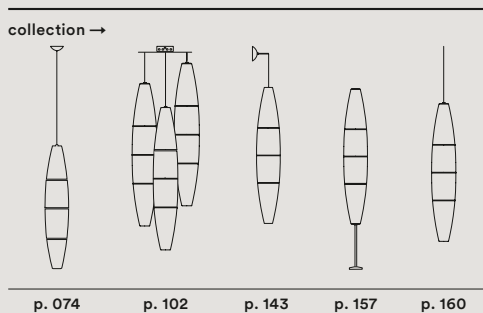
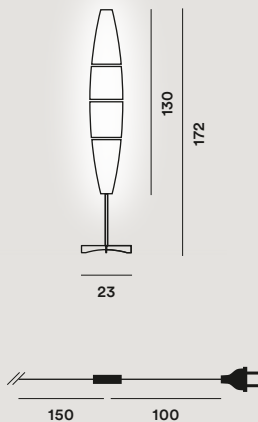

045

Lightwing

Jean Marie Massaud, 2013

LED



	energy cl.	colours	code	vat excluded
<i>Lightwing</i>	A ⁺	bianco	249003 10	1.264,00
		nero	249003 20	

Varnished aluminum and zinc alloy

LED included
34W 3000°K 3157 lm
CRI > 90 92,9 lm/W

Dimmer included

Adjustable lampshade

⊕ CE ▽ IP 20

Colours:
bianco, nero



Special colours
on request

Weight:
net kg 11,00

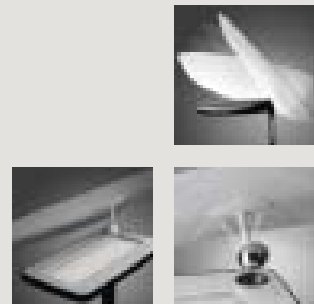
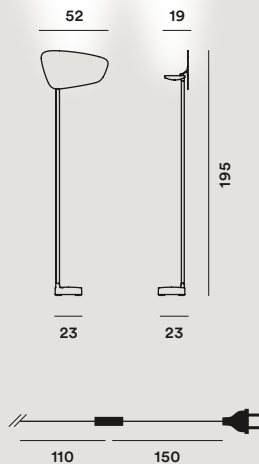

Lumiere xxl

Rodolfo Dordoni,
2009/2015



	energy cl.	colours	code	vat excluded
<i>Lumiere xxl</i>	C	alluminio/bianco	191004A 11	1.000,00
		alluminio/grigio	191004A 24	
		alluminio/marrone	191004A 55	
		cromo nero/bianco	191004C 11	
		cromo nero/grigio	191004C 24	
		cr. nero/marrone	191004C 55	

Spare parts:

<i>Glass Lumiere xxl</i>	bianco	191S001 11	335,00
	grigio	191S001 24	
	marrone	191S001 55	

Blown glass and lacquered aluminium

Lumiere xxl
Halo 4x33W G9
Dimmer included



Glass colours: bianco, grigio freddo, marrone freddo

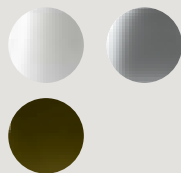

Weight:
net kg 9,00

Halo light bulbs not included
→ specifications p. 170

Frame colours: alluminio, cromo nero



Special colours on request

Tecnico — 2016

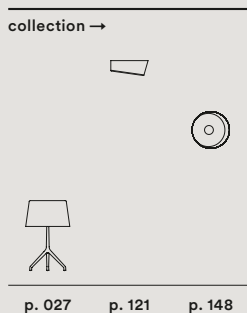
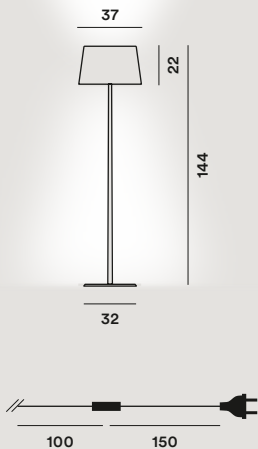

Magneto

Giuglio Iacchetti, 2011

LED

	energy cl.	colours	code	vat excluded
Magneto	A+	bianco	202004R2 10	366,00
		nero	202004R2 20	

Coated steel, ABS and super magnet made of "rare earth"

LED included
5W 2700° K 475 lm
CRI>80 95 lm/W

□ ▽ CE ◀ IP 20

Colours:
bianco, nero



Special colours
on request

Weight:
net kg 2,80

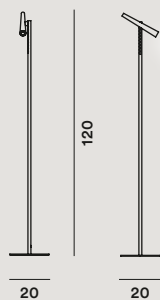

collection →



p. 028



Mite

Marc Sadler, 2000



	energy cl.	colours	code	vat excluded
<i>Mite halogen</i>	C	giallo	111003R2 55	805,00
		nero	111003R2 20	
<i>Mite LED</i>	A	giallo	111003L 55	1.087,00
		nero	111003L 20	
Spare parts:				
<i>Lampshade Mite</i>		giallo	111S00 55	427,00
		nero	111S00 20	
<i>Dimmer halogen version</i>			LTD RONDO T/I	39,00

Fiber glass fabric with Kevlar or carbonium thread, nickel-plated metal, steel and aluminium (LED)
Kevlar® is a Dupont registered trademark

Colours:
giallo, nero

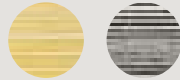

Weight:
halogen
net kg 7,70

Halo light bulbs not included
→ specifications p. 170

LED
net kg 7,70



Compasso
D'Oro 2001

Mite halogen
Halo 1x150W E27
Dimmer included (minimum bulb output 60W)*

Mite LED
LED included
32W 3000°K 2500 lm
CRI>90 78,1 lm/W
Dimmer included

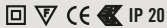

Tecnico — 2016

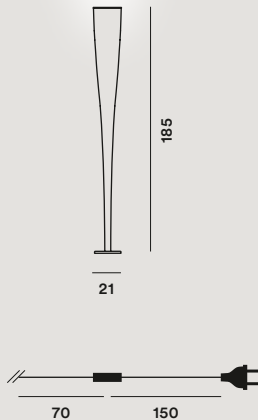

collection →

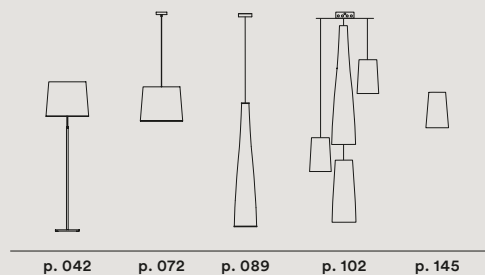

Orbital

Ferruccio Laviani, 1992



Silkscreen-printed glass and lacquered metal

Halo 5x30W E14



	energy cl.	colours	code	vat excluded
<i>Orbital</i>	A ⁺ , A, B, C	bianco	036003 10	866,00
		colorato	036003	
Spare parts:				
<i>Glass set Orbital</i>		bianco	036S01 10	220,00
		colorato	036S01	
<i>Glass Orbital 1</i>		bianco	043S00/1 10	50,00
		rosso	043S00/1 63	
<i>Glass Orbital 2</i>		bianco	043S00/2 10	50,00
		blu	043S00/2 33	
<i>Glass Orbital 3</i>		bianco	043S00/3 10	50,00
<i>Glass Orbital 4</i>		bianco	043S00/4 10	50,00
		verde	043S00/4 40	
<i>Glass Orbital 5</i>		bianco	043S00/5 10	50,00
		arancio	043S00/5 52	

Colours:
bianco, colorato



Special colours
on request

Weight:
net kg 10,10

Halo light bulbs not
included
→ specifications p. 170

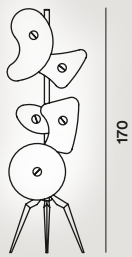

53

collection →



100 150

p. 132

Stewie

Luca Nichetto, 2012



	energy cl.	colours	code	vat excluded
Stewie	A ⁺ , A	avorio/avorio	237003 50	767,00
		avorio/rosso	237003 63	

Fabric coated polyethylene foam and lacquered metal

Colours:
avorio, rosso

Weight:
net kg 4,50

Fluo light bulbs not included
→ specifications p. 170

Fluo 1x40W 2GX13

⊕ ⚡ CE IP 20

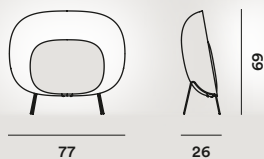

Tress

Marc Sadler, 2008

LED

Compound material on
lacquered fibre base, coated
metal and aluminium

Tress grande halogen

Halo 1x100W E27 PAR 30
+ Halo 1x230W R7s
Dimmer included
Double switch (minimum bulb
output 100W)*

Tress grande LED

LED included
56W 3000° K 3721 lm
CRI>90 66 lm/W
Dimmer included
Double switch

☐ ▽ CE IP 20

Tress media

Halo 1x100W E27 PAR 30
Dimmer included (minimum
bulb output 60W)*

☐ ▽ CE IP 20

	energy cl.	colours	code	vat excluded
Tress grande halogen	C	bianco	182003 10	1.204,00
		nero	182003 20	
		cremisi	182003 67	
		greige	182003 25	
		indaco	182003 87	
Tress grande LED	A	bianco	182003L 10	1.726,00
		nero	182003L 20	
		cremisi	182003L 67	
		greige	182003L 25	
		indaco	182003L 87	
Tress media	C	bianco	182004 10	645,00
		nero	182004 20	
		cremisi	182004 67	
		greige	182004 25	
		indaco	182004 87	

Spare parts:

Lampshade Tress media	bianco	182S02 10	477,00
	nero	182S02 20	
	cremisi	182S02 67	
	greige	182S02 25	
	indaco	182S02 87	

Dimmer Tress grande halogen	LTD RONDO4F/I	39,00
Dimmer Tress media	LTD RONDO T/I	39,00
Halogen protection glass Tress grande	PIREX138/2S4I	18,00

Colours: bianco, nero,
rosso, greige, indaco



Weight:
Tress grande
net kg 8,50

Tress media
net kg 3,90

Tress grande LED
net kg 11,00

Halo light bulbs not
included
→ specifications p. 170

Special colours
on request

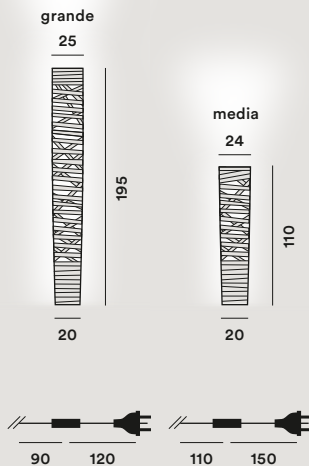

collection →

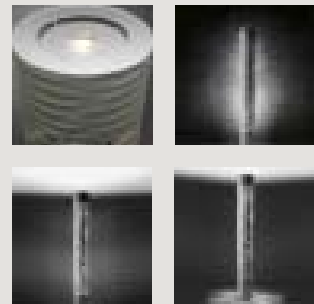
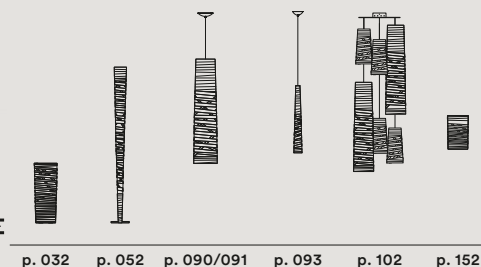

Tress Stilo

Marc Sadler, 2011

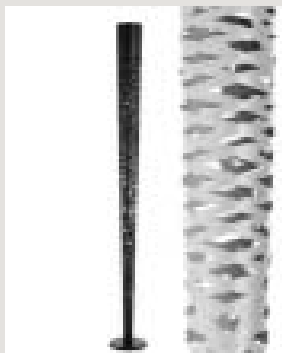

Coated fibreglass-based composite material, lacquered metal and steel

Halo 1x100W E27 PAR 30
Dimmer included (minimum bulb output 60W)*



	energy cl.	colours	code	vat excluded
<i>Tress Stilo</i>	C	bianco	182043 10	772,00
		nero	182043 20	

Spare parts:

<i>Lampshade Tress Stilo</i>	bianco	182S143 10	462,00
	nero	182S143 20	
<i>Dimmer</i>		LTD RT81 T/I	29,00

Colours:
bianco, nero

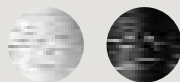

Special colours
on request

Weight:
net kg 4,20

Halo light bulbs not
included
→ specifications p. 170

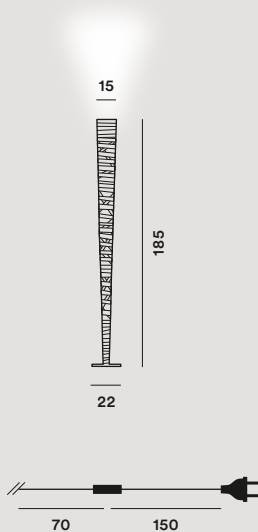

collection →

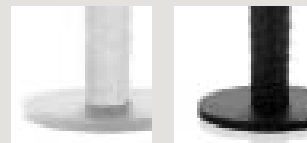
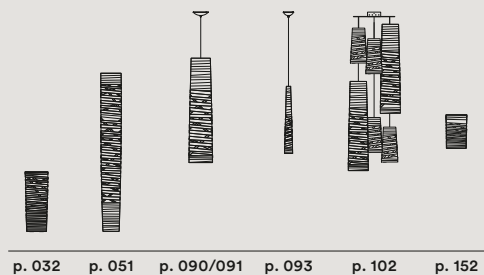

Tuareg

Ferruccio Laviani, 2013



	energy cl.	colours	code	vat excluded
<i>Tuareg</i>	A	arancio	255003 53	2.605,00
		cromo nero	255003 78	2.941,00

Varnished aluminium and polycarbonate

LED included
54W 3000°K 4050 lm
CRI > 90 75 lm/W

Separate switches and orientable lights
Touch dimmer included

☐ ▽ CE ◀ IP 20

Colours:
arancio, cromo nero



Special colours
on request

Weight:
net kg 9,20

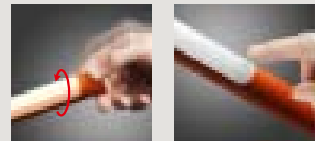
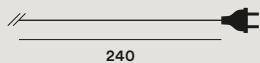
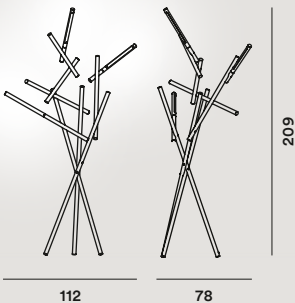

Twiggy

Marc Sadler, 2006

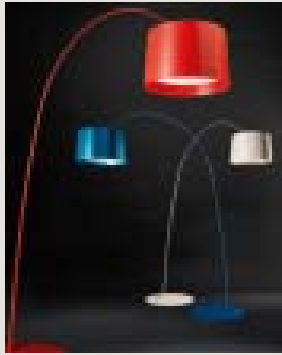

Coated fibreglass-based composite material, PMMA, polycarbonate, coated metal and aluminium (LED)

Twiggy halogen
Halo 3x77W E27
Dimmer included (minimum total bulb output 60W)*

Twiggy LED
LED included
33W 3000° K 2920 lm
CRI>90 88 lm/W
Dimmer included

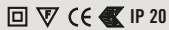

	energy cl.	colours	code	vat excluded
Twiggy halogen	C	bianco	159003 10	1.084,00
		nero	159003 20	
		greige	159003 25	
		cremisi	159003 67	
		indaco	159003 87	
Twiggy LED	A*	bianco	159003L 10	1.517,00
		nero	159003L 20	
		greige	159003L 25	
		cremisi	159003L 67	
		indaco	159003L 87	

Accessories

Additional stem set Twiggy (40 cm +40 cm)	bianco	159S031 10	154,00
	nero	159S031 20	
	greige	159S031 25	
	cremisi	159S031 67	
	indaco	159S031 87	

Spare parts:

Lampshade Twiggy	bianco	159S10 10	464,00
	nero	159S10 20	
	greige	159S10 25	
	cremisi	159S10 67	
	indaco	159S10 87	

Dimmer for halogen version	LTD RONDO T/I	39,00
Lower diffusor disk	159R05	29,00

Colours: bianco, nero, cremisi, greige, indaco

Weight:
halogen
net kg 16,60

Halo light bulbs not included
→ specifications p. 170

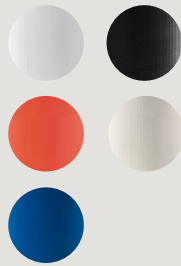

LED
net kg 17,10

Special colours on request

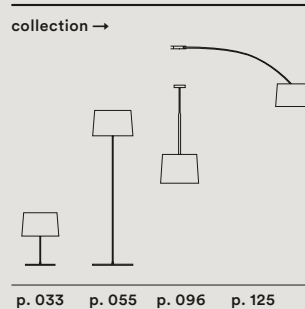
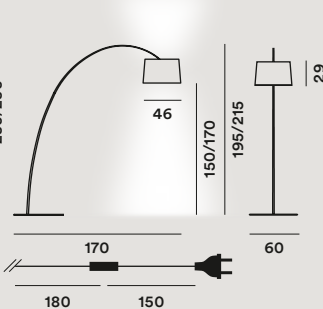
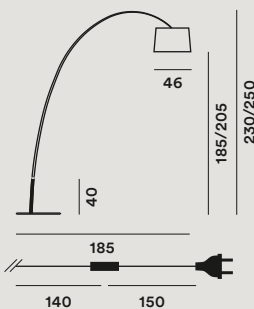
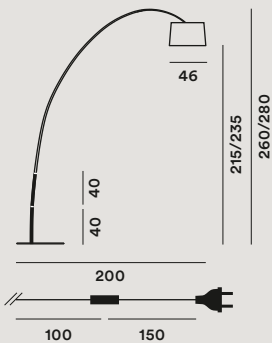

Tecnico — 2016

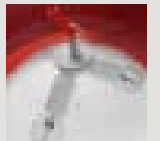

p. 033 p. 055 p. 096 p. 125

Twiggy Lettura

Marc Sadler, 2008



Coated fibreglass-based composite material, PMMA, polycarbonate and coated metal

Halo 3x77W E27
Dimmer included (minimum total bulb output 60W)

☐ ⚡ CE IP 20

	energy cl.	colours	code	vat excluded
<i>Twiggy lettura</i>	C	bianco	159004 10	882,00
		nero	159004 20	
Spare parts:				
<i>Lampshade Twiggy</i>		bianco	159S10 10	464,00
		nero	159S10 20	
<i>Dimmer</i>			LTD RONDO T/I	39,00

Colours:
bianco, nero



Special colours
on request

Weight:
net kg 11,30

Halo light bulbs not
included
→ specifications p. 170

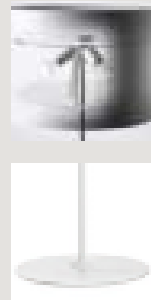
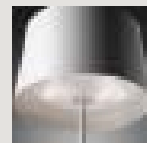
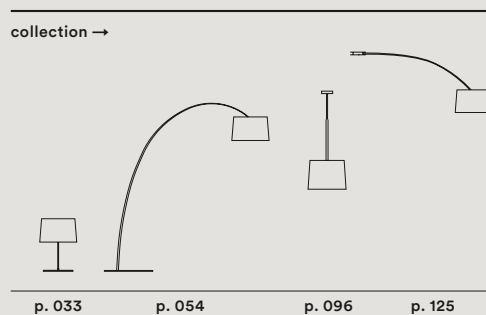
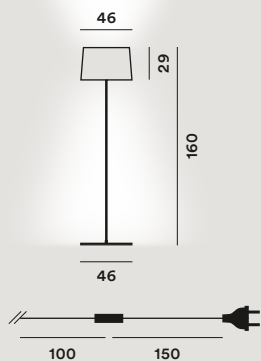



Sospensione, *Suspension*

- | | | | |
|-----------|---------------------------------|-----------|--------------------------------|
| 059 | Allegro | 079 | New Buds |
| 058 | Allegretto | 080 | O-Space |
| 060 - 061 | Aplomb +
Aplomb mini | 081 | Planet |
| 062 | Behive | 082 - 083 | Plass +
Plass media |
| 063 | Big Bang | 084 | Rituals |
| 064 | Birdie | 086 | Spokes |
| 065 - 067 | Caboche | 087 | Supernova |
| 068 | Caiigo | 088 | Tartan |
| 069 | Chouchin | 089 | Tite |
| 072 | Giga-Lite | 090 - 092 | Tress |
| 073 | Gregg | 092 | Tress Stilo |
| 074 | Havana | 094 | Troag |
| 075 | Jamaica | 095 | Tropico |
| 076 | Le Soleil | 096 | Twiggy |
| 077 | Lightweight | 097 | Uto |
| 078 | Maki | 098 | Wave |

Allegretto

Atelier Oi, 2009



	energy cl.	colours	code	vat excluded
<i>Allegretto Ritmico</i>	A ⁺ , A, B, C	nero	1690171 20	1.454,00
<i>Allegretto Ritmico H. 5 m</i>		nero	1690171SP5 20	1.529,00
<i>Allegretto Vivace</i>	A ⁺ , A, B, C	marrone	1690172 80	1.748,00
<i>Allegretto Vivace H. 5 m</i>		marrone	1690172SP5 80	1.823,00
<i>Allegretto Assai</i>	A ⁺ , A, B, C	oro	1690173 71	2.010,00
<i>Allegretto Assai H. 5 m</i>		oro	1690173SP5 71	2.085,00

Accessories:

<i>Decentralization kit</i> for steel cables	KIT DEC B	25,00
for steel cables + canopy	KIT DEC F	45,00

Varnished aluminium and metal

LED retrofit
2x12W E27 PAR 30
Halo 2x100W E27 PAR 30



Colours: Assai oro,
Vivace marrone,
Ritmico nero



Weight:
Allegretto Ritmico
net kg 5,10

Allegretto Vivace
net kg 9,10

Allegretto Assai
net kg 11,30

Halo, LED retrofit light
bulbs not included
→ specifications p. 170

Decentralization
→ specifications p. 106

Special colours
on request

Ritmico

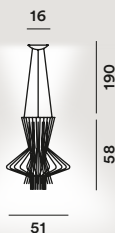

Vivace

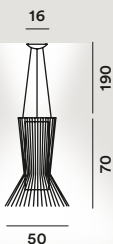

Assai

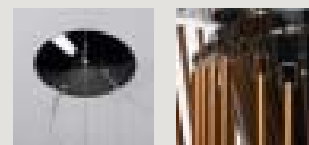
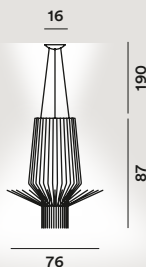

Allegro + Allegro LED

Atelier Oi, 2007



Varnished aluminium and metal

Allegro LED included
63W 3000°K 5000 lm
CRI>90 79,4 lm/W
Dimmable
Possible configurations:
On-Off/Push/DALI

Allegro halogen
Halo 1x230W R7s +
Halo 1x100W E27 PAR 30

Double switch



	energy cl.	colours	code	vat excluded
<i>Allegro Ritmico LED</i>	A	nero	1690071L 20	2.891,00
<i>Allegro Vivace LED</i>		marrone	1690072L 80	3.731,00
<i>Allegro Assai LED</i>		oro	1690073L 71	5.462,00
<i>Allegro Ritmico halogen</i>	C	nero	1690071 20	2.555,00
<i>Allegro Vivace halogen</i>		marrone	1690072 80	3.395,00
<i>Allegro Assai halogen</i>		oro	1690073 71	5.126,00

Spare parts:

<i>Halogen protection glass</i>	PIREX138/4/1	24,00
---------------------------------	--------------	-------

Accessories:

<i>Decentralization kit</i> for steel cables	KIT DEC B	25,00
for steel cables + canopy	KIT DEC F	45,00

Colours: Assai oro,
Vivace marrone,
Ritmico nero

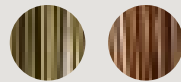

Special colours
on request

Weight:
Allegro Ritmico
net kg 15,00

Allegro Vivace
net kg 19,30

Allegro Assai
net kg 36,00

Allegro Ritmico LED
net kg 13,80

Allegro Vivace LED
net kg 18,10

Allegro Assai LED
net kg 34,80

Halo light bulbs not
included
→ specifications p. 170

Decentralization
→ specifications p. 106

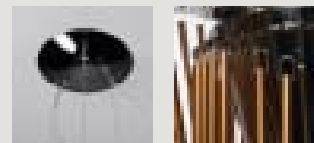
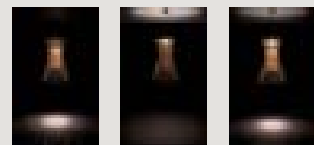
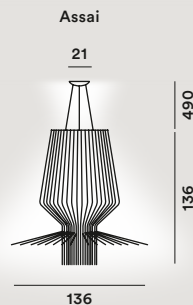
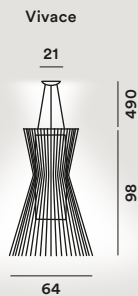
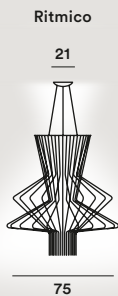

Aplomb

Lucidi e Pevere, 2010



Concrete and aluminium

Aplomb G9 halogen

Halo 1x60W



Aplomb GU10

LED retrofit 1x8W PAR 16



	energy cl.	colours	code	vat excluded
<i>Aplomb G9 halogen</i>	C	bianco	195007 10	294,00
		grigio	195007 25	
		marrone	195007 52	
<i>Aplomb G9 H. 5 m</i>		bianco	195007SP5 10	315,00
		grigio	195007SP5 25	
		marrone	195007SP5 52	
<i>Aplomb GU10</i>	A+, A	bianco	195007L 10	294,00
		grigio	195007L 25	
		marrone	195007L 52	
<i>Aplomb GU10 H. 5 m</i>		bianco	195007LSP5 10	315,00
		grigio	195007LSP5 25	
		marrone	195007LSP5 52	

Version without canopy with multiple canopy holder

<i>Aplomb G9 halogen</i>	C	bianco	195007SR 10	285,00
		grigio	195007SR 25	
		marrone	195007SR 52	
<i>Aplomb G9 H. 5 m</i>		bianco	195007SR5 10	306,00
		grigio	195007SR5 25	
		marrone	195007SR5 52	
<i>Aplomb GU10</i>	A+, A	bianco	195007LSR 10	285,00
		grigio	195007LSR 25	
		marrone	195007LSR 52	
<i>Aplomb GU10 H. 5 m</i>		bianco	195007LSR5 10	306,00
		grigio	195007LSR5 25	
		marrone	195007LSR5 52	

Accessories:

<i>Decentralization kit</i> for power cable	KIT DEC C	33,00
canopy for electrical dec.	KIT DEC M	79,00

Colours: bianco, grigio
cemento, marrone

Weight:
net kg 1,90

Halo, LED retrofit light
bulbs not included
→ specifications p. 170

Multiple canopy
→ specifications p. 100

Decentralization
→ specifications p. 106

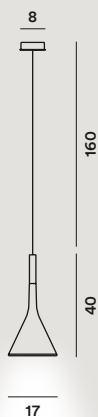

p. 038

p. 102

p. 128

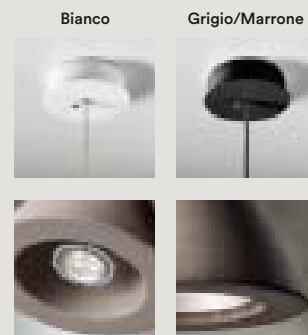

Aplomb mini

Lucidi e Pevere, 2015



Concrete

LED retrofit GU10
1x8W PAR 16



	energy cl.	colours	code	vat excluded
<i>Aplomb mini</i>	A+, A	bianco	195027 10	210,00
		grigio	195027 25	
		marrone	195027 52	
<i>Aplomb mini H. 5 m</i>	A+, A	bianco	195027/5 10	231,00
		grigio	195027/5 25	
		marrone	195027/5 52	
Version without canopy with multiple canopy holder				
<i>Aplomb mini</i>	A+, A	bianco	195027SR 10	201,00
		grigio	195027SR 25	
		marrone	195027SR 52	
<i>Aplomb mini H. 5 m</i>	A+, A	bianco	195027SR5 10	222,00
		grigio	195027SR5 25	
		marrone	195027SR5 52	

Accessories:

<i>Decentralization kit</i> for power cable	KIT DEC C	33,00
canopy for electrical dec.	KIT DEC M	79,00

Colours: bianco, grigio
cemento, marrone

Weight:
net kg 0,70

LED retrofit light bulbs
not included
→ specifications p. 170

Multiple canopy
→ specifications p. 100

Decentralization
→ specifications p. 106



p. 038 p. 102 p. 128

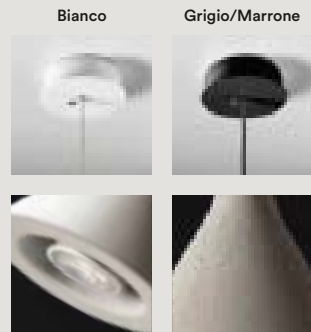

Behive

Werner Aisslinger, 2012



	energy cl.	colours	code	vat excluded
<i>Behive</i>	A ⁺ , A, B, C	bianco	203007 10	437,00
<i>Behive H. 5 m</i>		bianco	203007SP5 10	471,00

Spare parts:

<i>Lampshade Behive</i>	bianco	203S007 10	211,00
<i>Protection glass</i>		203V02/I	49,00

Accessories:

<i>Decentralization kit</i> for steel cables		KIT DEC B	25,00
	for steel cables + canopy	KIT DEC F	45,00
	canopy for electrical dec.	KIT DEC M	79,00

Batch-dyed ABS and polycarbonate

LED retrofit / Fluo
1x25W E27
Halo 1x150W E27



Colours: bianco



Special colours on request

Weight:
net kg 3,10

Halo, Fluo, LED retrofit light bulbs not included
→ specifications p. 170

Decentralization
→ specifications p. 106

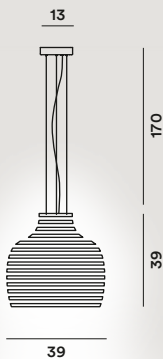

collection →

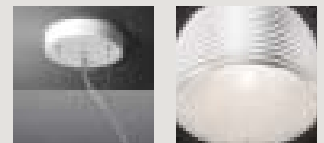

Big Bang

Enrico Franzolini con
Vicente Garcia Jimenez, 2005

LED

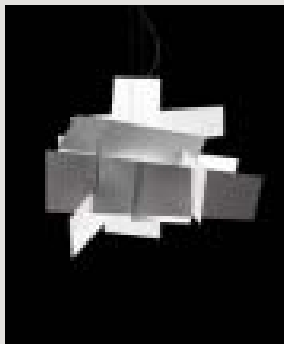

Methacrylate and coated
aluminium

Big Bang LED Included
37,7 W 3000° K
3260 lm CRI>90 88 lm/W
Dimmable LED version
Possible configurations:
On-Off/Push/DALI

Big Bang halogen
Halo 1x160W R7s

Big Bang fluorescent
Fluo 1x26W GX24q-3

⊕ ∇ CE IP 20

Big Bang xl halogen
Halo 1x160W R7s

⊕ ∇ CE IP 20

	energy cl.	colours	code	vat excluded	
Big Bang LED	A+	bianco	151007L 10	1.082,00	
		rosso	151007L 63	1.199,00	
Big Bang LED dimmable	A+	bianco	151007LD 10	1.168,00	
		rosso	151007LD 63	1.285,00	
Big Bang LED H. 5 m		bianco	151007LSP5 10	1.129,00	
		rosso	151007LSP5 63	1.246,00	
Big Bang LED H. 5 m dimmable		bianco	151007LD5 10	1.215,00	
		rosso	151007LD5 63	1.332,00	
Big Bang halogen	C	bianco	151007 10	639,00	
		rosso	151007 63	756,00	
Big Bang H. 5 m halogen		bianco	151007 10SP5	685,00	
		rosso	151007 63SP5	802,00	
Big Bang fluorescent	A+, A	bianco	151007F 10	665,00	
		rosso	151007F 63	782,00	
Big Bang xl halogen	C	bianco	1510072 10	3.474,00	
		rosso	1510072 63	4.002,00	
Spare parts:					
Set lampshades Big Bang		bianco	151S00 10	259,00	
		rosso	151S00 63	376,00	
Halogen protection glass			PIREX180-50/I	23,00	
Accessories:					
Decentralization kit for steel cables			KIT DEC B	25,00	
			for steel cables + canopy	KIT DEC F	45,00
			canopy for electrical dec.	KIT DEC M	79,00

Colours:
bianco, rosso



Special colours
on request

Weight:
Big Bang LED
net kg 7,40

Big Bang
net kg 5,40

Big Bang xl
net kg 35,00

Halo, Fluo light bulbs
not included
→ specifications p. 170

Decentralization
→ specifications p. 106

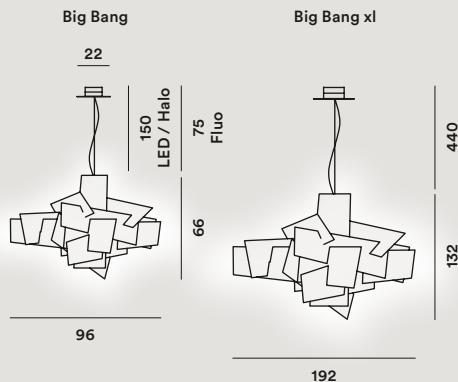

collection →



Birdie

Ludovica e Roberto
Palomba, 2013



Metallized polycarbonate
and metallized steel

Birdie grande bianco
LED retrofit / Fluo 1x25W E27
Halo 1x150W E27

Birdie piccola bianco
LED retrofit / Fluo 1x20W E27
Halo 1x70W E27

Birdie grande Metal
LED retrofit / Fluo 1x25W E27

Birdie piccola Metal
LED retrofit / Fluo 1x20W E27



	energy cl.	colours	code	vat excluded
<i>Birdie grande</i>	A+, A, B, C	bianco	221017 10	193,00
<i>Birdie grande H. 5 m</i>		bianco	221017/5 10	218,00
<i>Birdie piccola</i>		bianco	221027 10	164,00
<i>Birdie piccola H. 5 m</i>		bianco	221027/5 10	189,00
<i>Birdie grande Metal</i>	A+, A	rame	221017 57	277,00
		cromo	221017 78	
<i>Birdie grande Metal H. 5 m</i>		rame	221017/5 57	302,00
		cromo	221017/5 78	
<i>Birdie piccola Metal</i>		rame	221027 57	210,00
		cromo	221027 78	
<i>Birdie piccola Metal H. 5 m</i>		rame	221027/5 57	235,00
		cromo	221027/5 78	

Version without canopy with multiple canopy holder

<i>Birdie grande</i>	A+, A, B, C	bianco	221017SR 10	173,00
<i>Birdie grande H. 5 m</i>		bianco	221017SR5 10	198,00
<i>Birdie piccola</i>		bianco	221027SR 10	144,00
<i>Birdie piccola H. 5 m</i>		bianco	221027SR5 10	169,00
<i>Birdie grande Metal</i>	A+, A	rame	221017SR 57	257,00
		cromo	221017SR 78	
<i>Birdie grande Metal H. 5 m</i>		rame	221017SR5 57	282,00
		cromo	221017SR5 78	
<i>Birdie piccola Metal</i>		rame	221027SR 57	190,00
		cromo	221027SR 78	
<i>Birdie piccola Metal H. 5 m</i>		rame	221027SR5 57	215,00
		cromo	221027SR5 78	

Accessories:

<i>Decentralization kit</i> for power cable	KIT DEC C	33,00
canopy for electrical dec.	KIT DEC M	79,00

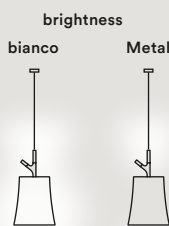

Colours: bianco,
cromo nero, rame

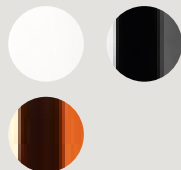

Weight:
Birdie grande
net kg 1,30

Birdie piccola
net kg 1,00

Halo, Fluo, LED retrofit
light bulbs not included
→ specifications p. 170

Decentralization
→ specifications p. 106

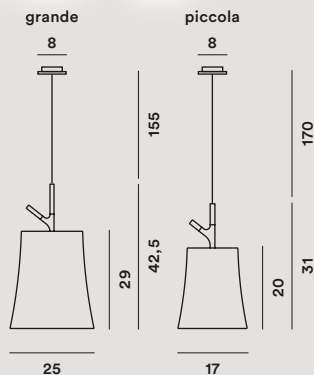

collection →

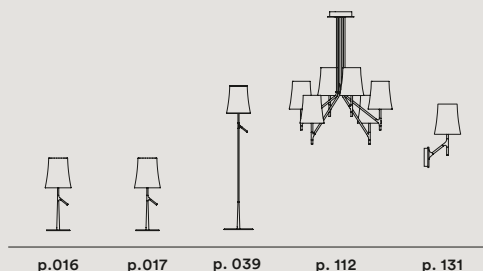

Caboche grande

Patricia Urquiola
e Eliana Gerotto, 2005



PMMA, blown glass,
chromed metal and
aluminium (LED)

Caboche grande

LED Included

46W 3000°K 4330 lm

CRI > 90 94,1 lm/W

Dimmable LED version

Possible configurations:

On-Off/Push/DALI

Caboche grande halogen

Halo 1x230W R7s

⊕ ⊖ CE IP 20



	energy cl.	colours	code	vat excluded
<i>Caboche grande LED</i>	A+	trasparente	138017L 16	2.101,00
		giallo oro	138017L 52	
<i>Caboche grande LED</i> <i>H. 5 m</i>		trasparente	138017LSP5 16	2.210,00
		giallo oro	138017LSP5 52	
<i>Caboche grande LED</i> <i>dimmable</i>	A+	trasparente	138017LD 16	2.185,00
		giallo oro	138017LD 52	
<i>Caboche grande LED</i> <i>H. 5 m dimmable</i>		trasparente	138017LD5 16	2.294,00
		giallo oro	138017LD5 52	
<i>Caboche grande halogen</i>	C	trasparente	138017 16	1.479,00
		giallo oro	138017 52	
<i>Caboche grande H. 5 m</i>		trasparente	138017SP5 16	1.588,00
		giallo oro	138017SP5 52	

Spare parts:

<i>Set spheres Caboche grande</i>	trasparente	138S001 16	599,00
	giallo oro	138S001 52	
<i>Kit 20 pron. 4 spheres Caboche</i>		138KIT 20G4	34,00
<i>Kit 20 pron. 5 spheres Caboche</i>		138KIT 20G5	34,00
<i>Kit 3+3 pron. 4+5 spheres Caboche</i>		138KIT1-R2	18,00
<i>Inner glass Caboche LED</i>		138V0118/I	121,00
<i>Inner glass Caboche halogen</i>		138V011/I	117,00
<i>Halogen protection glass</i>		PIREX138/2S4I	18,00
<i>Halogen protection disk Caboche</i>		138V021/I	44,00

Accessories:

<i>Decentralization kit</i> for steel cables		KIT DEC B	25,00
	for steel cables + canopy	KIT DEC F	45,00
	canopy for electrical dec.	KIT DEC M	79,00

Colours:
bianco, giallo oro

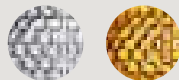

Special colours
on request

Weight:
Caboche grande
LED
net kg 17,00

Caboche grande
halogen
net kg 19,60

Halo light bulbs not
included
→ specifications p. 170

Decentralization
→ specifications p. 106

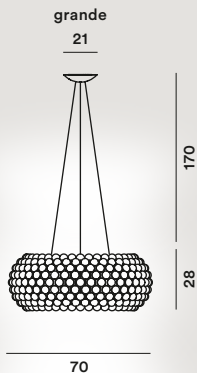

collection →

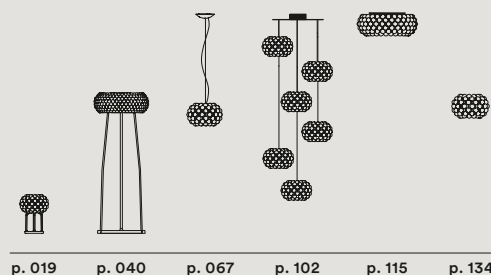

Caboche media

Patricia Urquiola
e Eliana Gerotto, 2005



PMMA, blown glass,
chromed metal and
aluminium (LED)

Caboche media
LED Included
35W 3000°K 3062 lm
CRI > 90 88 lm/W
Dimmable LED version
Possible configurations:
On-Off/Push/DALI

Caboche media halogen
Halo 1x160W R7s

⊕ ⚡ ⚡ IP 20



	energy cl.	colours	code	vat excluded
<i>Caboche media LED</i>	A+	trasparente	138007L 16	1.168,00
		giallo oro	138007L 52	
<i>Caboche media LED</i> <i>H. 5 m</i>		trasparente	138007LSP5 16	1.209,00
		giallo oro	138007LSP5 52	
<i>Caboche media LED</i> <i>dimmable</i>	A+	trasparente	138007LD 16	1.252,00
		giallo oro	138007LD 52	
<i>Caboche media LED</i> <i>dimmable H. 5 m</i>		trasparente	138007LD5 16	1.293,00
		giallo oro	138007LD5 52	
<i>Caboche media halogen</i>	C	trasparente	138007 16	829,00
		giallo oro	138007 52	
<i>Caboche media H. 5 m</i> <i>halogen</i>		trasparente	138007 16SP5	893,00
		giallo oro	138007 52SP5	

Spare parts:

<i>Set spheres Caboche media</i>	trasparente	138S00 16	322,00
	giallo oro	138S00 52	
<i>Kit 15 pron. 3 spheres Caboche</i>		138KIT 15M3	26,00
<i>Kit 15 pron. 4 spheres Caboche</i>		138KIT 15M4	26,00
<i>Kit 3+3 pron. 3 + 4 spheres Caboche</i>		138KIT-R2	19,00
<i>Inner glass Caboche halogen</i>		138V01R1/I	72,00
<i>Inner glass Caboche LED</i>		138V018/I	82,00
<i>Halogen protection glass</i>		PIREX138/2S4I	18,00
<i>Disco protezione halogen</i>		138V02/I	37,00

Accessories:

<i>Decentralization kit for steel cables</i>		KIT DEC B	25,00
	for steel cables + canopy	KIT DEC F	

Colours:
bianco, giallo oro

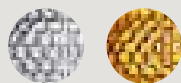

Special colours
on request

Weight:
Caboche media
LED
net kg 10,20

Caboche media
halogen
net kg 10,20

Halo light bulbs not
included
→ specifications p. 170

Decentralization
→ specifications p. 106

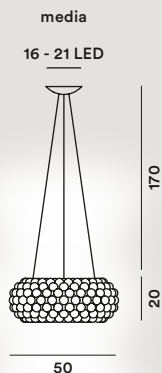

collection →

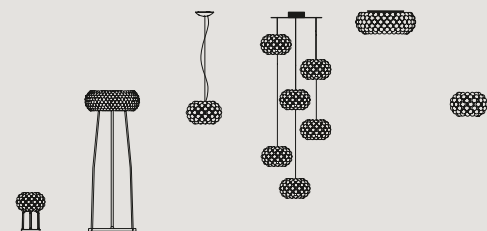

p. 019 p. 040 p. 067 p. 102 p. 115 p. 134



Caboche piccola

Patricia Urquiola
e Eliana Gerotto, 2005



PMMA, blown glass and
chromed metal

Halo 1x60W G9



	energy cl.	colours	code	vat excluded
<i>Caboche piccola</i>	C	trasparente	138027 16	403,00
		giallo oro	138027 52	
<i>Caboche piccola H. 5 m</i>		trasparente	138027SP5 16	454,00
		giallo oro	138027SP5 52	

Version without canopy with multiple canopy holder

<i>Caboche piccola</i>	C	trasparente	138027SR 16	383,00
		giallo oro	138027SR 52	
<i>Caboche piccola H. 5 m</i>		trasparente	138027SR5 16	434,00
		giallo oro	138027SR5 52	

Spare parts:

<i>Set spheres Caboche piccola</i>	trasparente	138S002 16	160,00
	giallo oro	138S002 52	
<i>Kit 10 prongs 3 spheres Caboche</i>		138KIT 10P3	23,00
<i>Kit 10 prongs 4 spheres Caboche</i>		138KIT 10P4	23,00
<i>Kit 3+3 prongs 3 + 4 spheres Caboche</i>		138KIT2-R2	18,00
<i>Inner glass Caboche piccola</i>		138V012/1	39,00

Accessories:

<i>Decentralization kit</i> for steel cables		KIT DEC B	25,00
	for steel cables + canopy	KIT DEC F	45,00
	canopy for electrical dec.	KIT DEC M	79,00

Colours:
bianco, giallo oro

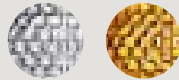

Special colours
on request

Weight:
net kg 4,80

Halo light bulbs not
included
→ specifications p. 170

Multiple canopy
→ specifications p. 100

Decentralization
→ specifications p. 106

piccola

16

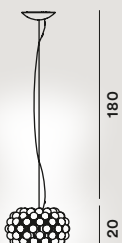

31

collection →

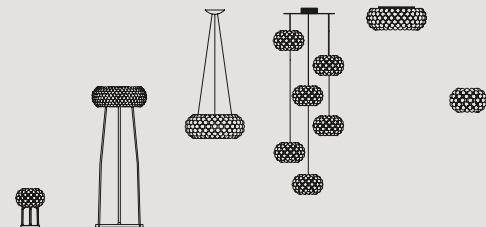

p. 019 p. 040 p. 065/066 p. 102 p. 115 p. 139



068 Sospensione, *Suspension*

Caiigo

Marco Zito, 2016



Blown glass and aluminium

LED retrofit
1x8W GU10 PAR 16
Halo 1x35W GU10 PAR 16



	energy cl.	colours	code	vat excluded
<i>Caiigo</i>	A ⁺⁺ , A ⁺ , A, B, C	bianco	266007 15	403,00
<i>Caiigo H. 5 m</i>		bianco	266007/5 15	433,00

Version without canopy with multiple canopy holder

<i>Caiigo</i>		bianco	266007SR 15	393,00
<i>Caiigo H. 5 m</i>		bianco	266007SR5 15	423,00

Ricambi:

<i>Lampshade Caiigo</i>		bianco	266S00 15	244,00
-------------------------	--	--------	-----------	--------

Accessories:

<i>Decentralization kit</i> for steel cables			KIT DEC B	25,00
			for steel cables + canopy	45,00
			canopy for electrical dec.	79,00

Colours:
bianco sfumato



Weight:
net kg 2,00

Halo, LED retrofit light
bulbs not included
→ specifications p. 170

Multiple canopy
→ specifications p. 100

Decentralization
→ specifications p. 106

Tecnico — 2016

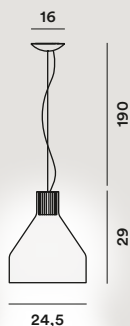

Chouchin

Ionna Vautrin, 2011

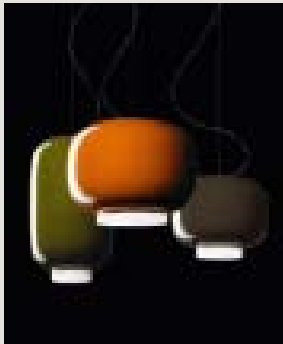

Lacquered blown glass

LED retrofit / Fluo

1x25W E27

Halo 1x100W E27 PAR 30 °

Halo 1x150W E27

⊕ ⚡ CE IP 20

	energy cl.	colours	code	vat excluded
<i>Chouchin 1</i>	A ⁺ , A, B, C	arancio	210071 53	406,00
<i>Chouchin 2</i>		verde	210072 40	392,00
<i>Chouchin 3</i>		grigio	210073 25	318,00
<i>Chouchin 1 H. 5 m</i>		arancio	210071SP5 53	448,00
<i>Chouchin 2 H. 5 m</i>		verde	210072SP5 40	434,00
<i>Chouchin 3 H. 5 m</i>		grigio	210073SP5 25	360,00

Version without canopy with multiple canopy holder

<i>Chouchin 1</i>	A ⁺ , A, B, C	arancio	210071SR 53	397,00
<i>Chouchin 2</i>		verde	210072SR 40	383,00
<i>Chouchin 3</i>		grigio	210073SR 25	309,00
<i>Chouchin 1 H. 5 m</i>		arancio	210071SR5 53	439,00
<i>Chouchin 2 H. 5 m</i>		verde	210072SR5 40	425,00
<i>Chouchin 3 H. 5 m</i>		grigio	210073SR5 25	351,00

Spare parts:

<i>Glass Chouchin 1</i>	arancio	210S001 53	300,00
<i>Glass Chouchin 2</i>	verde	210S002 40	271,00
<i>Glass Chouchin 3</i>	grigio	210S003 25	212,00

Accessories:

<i>Decentralization kit</i> for steel cables	KIT DEC B	25,00
for steel cables + canopy	KIT DEC F	45,00
canopy for electrical dec.	KIT DEC M	79,00

Colours:

Chouchin 1 arancio,
Chouchin 2 verde,
Chouchin 3 grigio



Special colours
on request

Weight:

Chouchin 1
net kg 4,40

Chouchin 2
net kg 2,90

Chouchin 3
net kg 3,60

Halo, Fluo, LED retrofit
light bulbs not included
→ specifications p. 170

Multiple canopy
→ specifications p. 100

Decentralization
→ specifications p. 106

Chouchin 1

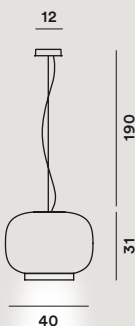

Chouchin 2

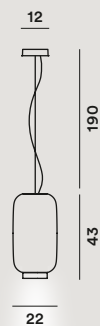

Chouchin 3



collection →

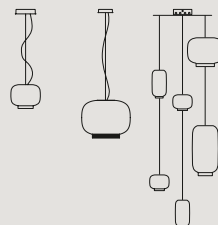

p. 070

p. 071

p. 102



Chouchin mini

Ionna Vautrin, 2013



Lacquered blown glass

LED retrofit / Fluo
1x8W GU10 PAR 16
Halo 1x35W GU10 PAR 16



	energy cl.	colours	code	vat excluded
<i>Chouchin mini 1</i>	A ⁺⁺ , A ⁺ , A, B, C	arancio	210271 53	213,00
<i>Chouchin mini 2</i>		verde	210272 40	235,00
<i>Chouchin mini 1 H. 5 m</i>		arancio	210271SP5 53	233,00
<i>Chouchin mini 2 H. 5 m</i>		verde	210272SP5 40	255,00

Version without canopy with multiple canopy holder

<i>Chouchin mini 1</i>	A ⁺⁺ , A ⁺ , A, B, C	arancio	210271SR 53	204,00
<i>Chouchin mini 2</i>		verde	210272SR 40	226,00
<i>Chouchin mini 1 H. 5 m</i>		arancio	210271SR5 53	224,00
<i>Chouchin mini 2 H. 5 m</i>		verde	210272SR5 40	246,00

Spare parts:

<i>Glass Chouchin mini 1</i>	arancio	210S021 53	118,00
<i>Glass Chouchin mini 2</i>	verde	210S022 40	118,00

Accessories:

<i>Decentralization kit</i> for steel cables	KIT DEC B	25,00
for steel cables + canopy	KIT DEC F	45,00
canopy for electrical dec.	KIT DEC M	79,00

Colours:
Chouchin mini 1 arancio,
Chouchin mini 2 verde



Special colours
on request

Weight:
Chouchin mini 1
net kg 1,00

Chouchin mini 2
net kg 1,10

Halo, Fluo, LED retrofit
light bulbs not included
→ specifications p. 170

Multiple canopy
→ specifications p. 100

Decentralization
→ specifications p. 106

mini 1

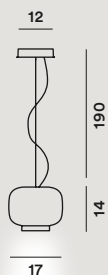

mini 2

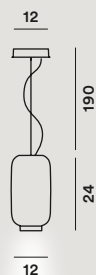

collection →

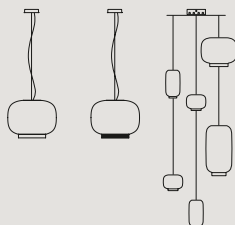

p. 069

p. 071

p. 102



Chouchin reverse

Ionna Vautrin, 2015



Lacquered blown glass

LED retrofit / Fluo
1x25W E27
Halo 1x150W E27

⊕ ⚡ CE Ⓢ IP 20

	energy cl.	colours	code	vat excluded
<i>Chouchin 1 reverse</i>	A ⁺ , A, B, C	bianco/arancio	210071 05	406,00
<i>Chouchin 2 reverse</i>		bianco/verde	210072 04	392,00
<i>Chouchin 3 reverse</i>		bianco/grigio	210073 02	318,00
<i>Chouchin 1 rev. H. 5 m</i>		bianco/arancio	210071SP5 05	448,00
<i>Chouchin 2 rev. H. 5 m</i>		bianco/verde	210072SP5 04	434,00
<i>Chouchin 3 rev. H. 5 m</i>		bianco/grigio	210073SP5 02	360,00

Version without canopy with multiple canopy holder

<i>Chouchin 1 reverse</i>	A ⁺ , A, B, C	bianco/arancio	210071SR 05	397,00
<i>Chouchin 2 reverse</i>		bianco/verde	210072SR 04	383,00
<i>Chouchin 3 reverse</i>		bianco/grigio	210073SR 02	309,00
<i>Chouchin 1 rev. H. 5 m</i>		bianco/arancio	210071SR5 05	439,00
<i>Chouchin 2 rev. H. 5 m</i>		bianco/verde	210072SR5 04	425,00
<i>Chouchin 3 rev. H. 5 m</i>		bianco/grigio	210073SR5 02	351,00

Spare parts:

<i>Glass Chouchin 1 reverse</i>	bianco/arancio	210S001 05	300,00
<i>Glass Chouchin 2 reverse</i>	bianco/verde	210S002 04	286,00
<i>Glass Chouchin 3 reverse</i>	bianco/grigio	210S003 02	212,00

Accessories:

<i>Decentralization kit</i> for steel cables	KIT DEC B	25,00
for steel cables + canopy	KIT DEC F	45,00
canopy for electrical dec.	KIT DEC M	79,00

Colours:

Chouchin reverse 1

bianco / arancio

Chouchin reverse 2

bianco / verde

Chouchin reverse 3

bianco / grigio



Weight:

Chouchin reverse 1

net kg 4,40

Chouchin reverse 2

net kg 2,90

Chouchin reverse 3

net kg 3,60

Halo, Fluo, LED retrofit

light bulbs not included

→ specifications p. 170

Multiple canopy

→ specifications p. 100

Decentralization

→ specifications p. 106

Special colours

on request

Chouchin 1

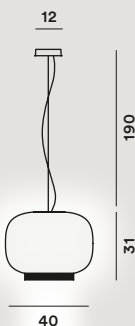

Chouchin 2

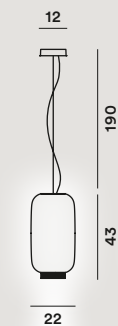

Chouchin 3



collection →

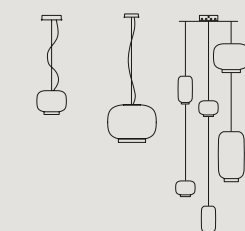

p. 070

p. 071

p. 102

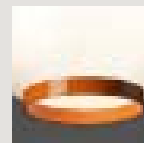

Giga-Lite

Marc Sadler, 2004

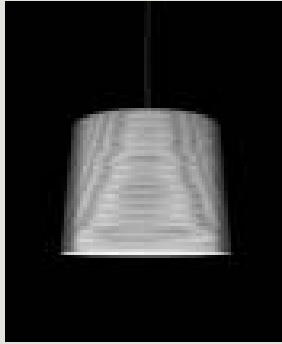

Fiberglass fabric with carbonium thread, steel and nickel-plated metal

LED retrofit / Fluo
3x20W E27
Halo 3x77W E27



	energy cl.	colours	code	vat excluded	
<i>Giga-Lite</i>	A ⁺ , A, B, C	nero	139017 20	669,00	
<i>Giga-Lite H. 5 m</i>		nero	139017 20 SP5	703,00	
Spare parts:					
<i>Lampshade Giga-Lite</i>		nero	139S001 20	371,00	
Accessories:					
<i>Decentralization kit</i> for power cable			KIT DEC C	33,00	
			canopy for electrical dec.	KIT DEC M	79,00

Colours: nero



Weight:
net kg 2,50

Halo, Fluo, LED retrofit
light bulbs not included
→ specifications p. 170

Decentralization
→ specifications p. 106

Tecnico — 2016

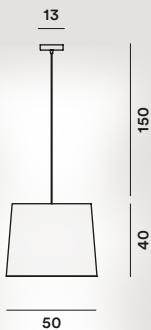

collection →

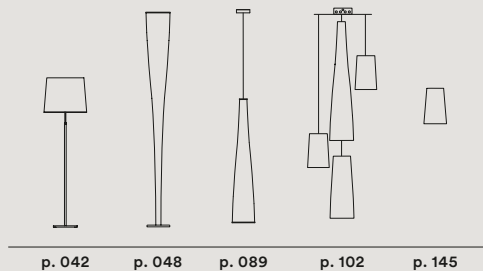

p. 042 p. 048 p. 089 p. 102 p. 145



GreggLudovica e Roberto
Palomba, 2007

Blown acid-etched glass

Gregg grandeLED retrofit / Fluo
1x30W E27
Halo 1x205W E27**Gregg media**LED retrofit / Fluo
1x25W E27
Halo 1x150W E27**Gregg piccola**

Halo 1x33W G9

	energy cl.	colours	code	vat excluded
Gregg grande	A ⁺ , A, B, C	bianco	1680071 10	462,00
Gregg grande H. 5 m		bianco	1680071SP5 10	506,00
Gregg media	A ⁺ , A, B, C	bianco	168007 10	316,00
Gregg media H. 5 m		bianco	168007 10SP5	360,00
Gregg piccola	C	bianco	1680072 10	141,00
Gregg piccola H. 5 m		bianco	1680072SP5 10	171,00

Version without canopy with multiple canopy holder

Gregg media	A ⁺ , A, B, C	bianco	168007SR 10	307,00
Gregg media H. 5 m		bianco	168007SR5 10	351,00
Gregg piccola	C	bianco	1680072SR 10	132,00
Gregg piccola H. 5 m		bianco	1680072SR5 10	162,00

Spare parts:

Glass Gregg grande	bianco	168S001 10	318,00
Glass Gregg media	bianco	168S00 10	172,00
Glass Gregg piccola	bianco	168S00210	59,00

Accessories:

Decentralization kit for steel cables	KIT DEC B	25,00
Gregg grande/media for steel cables + canopy	KIT DEC F	45,00
Gregg piccola for power cable	KIT DEC C	33,00
canopy for electrical dec.	KIT DEC M	79,00

Colours: bianco

Special colours
on request

Weight:

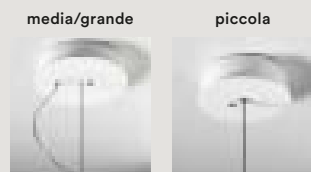
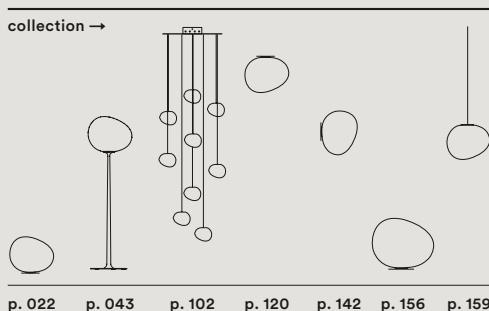
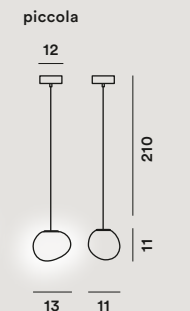
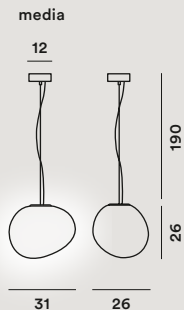
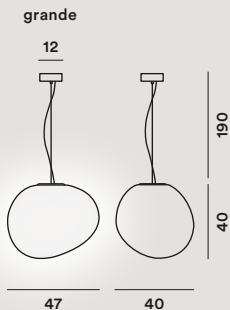
Gregg grande
net kg 5,60**Gregg media**
net kg 3,10**Gregg piccola**
net kg 0,70Halo, Fluo, LED retrofit
light bulbs not included
→ specifications p. 170Multiple canopy
→ specifications p. 100Decentralization
→ specifications p. 106

Havana

Joseph Forakis, 1993

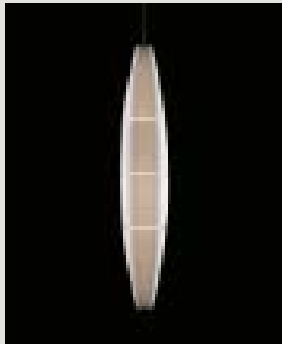

Injection moulded polyethylene and coated metal

LED retrofit / Fluo
1x25W E27
Halo 1x105W E27



Havana doppia, tripla, quadrupla



doppia tripla quadrupla

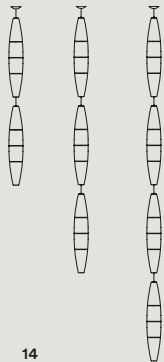

14

110

130

23

	energy cl.	colours	code	vat excluded
<i>Havana</i>	A ⁺ , A, B, C	bianco	0400072-R1 10	200,00
<i>Havana H. 5 m</i>		bianco	0400072SP5 10	234,00
<i>Havana doppia</i>		bianco	0400072SP2 10	842,00
<i>Havana tripla</i>		bianco	0400072SP3 10	1.222,00
<i>Havana quadrupla</i>		bianco	0400072SP4 10	1.602,00

Version without canopy with multiple canopy holder

<i>Havana</i>	A ⁺ , A, B, C	bianco	0400072SR 10	187,00
<i>Havana H. 5 m</i>		bianco	0400072SR5 10	221,00

Spare parts:

<i>Set lampshades Havana</i>	bianco	040S00 10	79,00
------------------------------	--------	-----------	-------

Accessories:

<i>Decentralization kit</i> for power cable		KIT DEC C	33,00
canopy for electrical dec.		KIT DEC M	79,00

Colours: bianco



Special colours on request

Weight:
net kg 1,90

Halo, Fluo, LED retrofit light bulbs not included
→ specifications p. 170

Multiple canopy
→ specifications p. 100

Decentralization
→ specifications p. 106

collection →

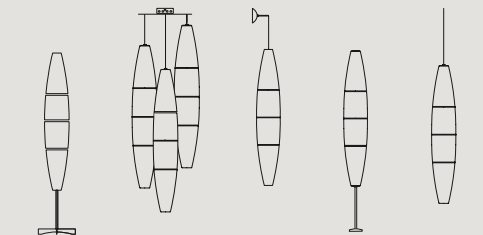

p. 044

p. 102

p. 143

p. 157

p. 160

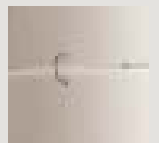

Jamaica

Marc Sadler, 2011



	energy cl.	colours	code	vat excluded
<i>Jamaica</i>	A ⁺ , A	bianco	225007 10	1.105,00
<i>Jamaica H. 5 m</i>		bianco	225007SP5 10	1.157,00
<i>Jamaica dimmable</i>	A ⁺ , A	bianco	225007DM 10	1.210,00
<i>Jamaica dimmable H. 5 m</i>		bianco	25007DMSP510	1.262,00
Spare parts:				
<i>Set lampshades Jamaica</i>		bianco	225S00 10	545,00
Accessories:				
<i>Decentralization kit</i>	canopy for electrical dec.		KIT DEC M	79,00

Paper tape coupled with techno polymer, PMMA and coated metal

Fluo 2x80W max. G5

Multiwatt ballast 35/49/80

Dimmable version

Possible configurations:

On-Off/Push/DALI

⊕ ⚡ CE IP 20

Colours: bianco



Weight:
net kg 6,00

Fluo light bulbs
not included
→ specifications p. 170

Decentralization
→ specifications p. 106

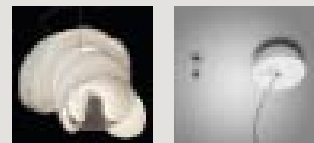
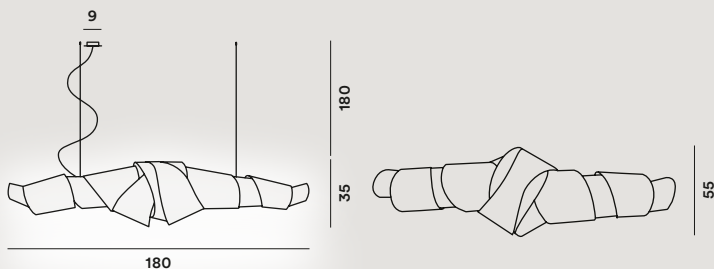

Le Soleil

Vincente Garcia Jimenez,
2009



Injection moulded polycarbonate and coated metal

Halo 3x60W G9 +
Halo 1x75W GU10 PAR 20

Le Soleil fluorescent
Fluo 1x42W GX24q-4
Multiwatt ballast 26/32/42

Dimmable version
Possible configurations:
On-Off/Push/DALI

⊕ ⊖ CE IP 20

	energy cl.	colours	code	vat excluded
<i>Le Soleil halogen</i>	C	bianco	181007 10	723,00
		acquamarina	181007 34	
		rosso	181007 63	
<i>Le Soleil halogen H. 5 m</i>		bianco	181007SP5 10	756,00
		acquamarina	181007SP5 34	
		rosso	181007SP5 63	
<i>Le Soleil fluorescent</i>	A ⁺ , A	bianco	181007F 10	782,00
		acquamarina	181007F 34	
		rosso	181007F 63	
<i>Le Soleil fluorescent H. 5 m</i>		bianco	181007FSP5 10	830,00
		acquamarina	181007FSP5 34	
		rosso	181007FSP5 63	
<i>Le Soleil fluorescent dimmable</i>	A ⁺ , A	bianco	181007FDM 10	842,00
		acquamarina	181007FDM 34	
		rosso	181007FDM 63	
<i>Le Soleil fluorescent dimmable H. 5 m</i>		bianco	181007FDM5 10	890,00
		acquamarina	181007FDM5 34	
		rosso	181007FDM5 63	

Spare parts:

<i>Set lampshades Le Soleil</i>	bianco	181S00-R1 10	338,00
	acquamarina	181S00-R1 34	
	rosso	181S00-R1 63	

Accessories:

<i>Decentralization kit</i> for steel cables		KIT DEC B	25,00
	for steel cables + canopy	KIT DEC F	45,00
	canopy for electrical dec.	KIT DEC M	79,00

Colours: bianco, acquamarina, rosso

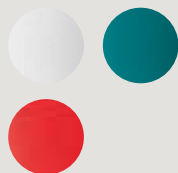

Special colours on request

Weight: net kg 5,30

Halo, Fluo light bulbs not included
→ specifications p. 170

Decentralization
→ specifications p. 106

collection →

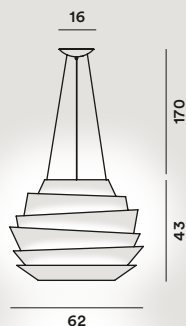

Lightweight

Tom Dixon, 1995



	energy cl.	colours	code	vat excluded
<i>Lightweight</i>	C	anodizzato	064007-R1 ZI	3.151,00
<i>Lightweight H. 5 m</i>		anodizzato	064007R1SP5ZI	3.198,00
Spare parts:				
<i>Glass</i>		bianco	061V01/I	23,00

Anodized metal

Halo 8x20W G4 12v

Colours: anodizzato

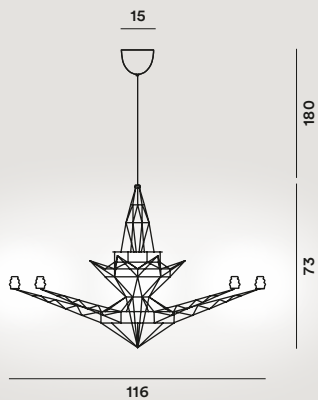
Weight:
net kg 7,60Halo, light bulbs
not included
→ specifications p. 170

Maki

Nendo, 2011



Lacquered aluminium

LED retrofit
1x8W GU10 PAR 16
Halo 1x35W GU10 PAR 16



	energy cl.	colours	code	vat excluded
<i>Maki</i>	A ⁺⁺ , A ⁺ , A, B, C	bianco	219007 10	227,00
		grigio	219007 25	
<i>Maki H. 5 m</i>		bianco	219007SP5 10	254,00
		grigio	219007SP5 25	

Version without canopy with multiple canopy holder

<i>Maki</i>	A ⁺⁺ , A ⁺ , A, B, C	bianco	219007SR 10	218,00
		grigio	219007SR 25	
<i>Maki H. 5 m</i>		bianco	219007SR5 10	245,00
		grigio	219007SR5 25	

Accessories:

<i>Decentralization kit</i> for power cable		KIT DEC C	33,00
canopy for electrical dec.		KIT DEC M	79,00

Colours:
bianco, grigio



Special colours
on request

Weight:
net kg 0,50

Halo, LED retrofit light
bulbs not included
→ specifications p. 170

Multiple canopy
→ specifications p. 100

Decentralization
→ specifications p. 106



p. 102



New Buds

Rodolfo Dordoni, 2007

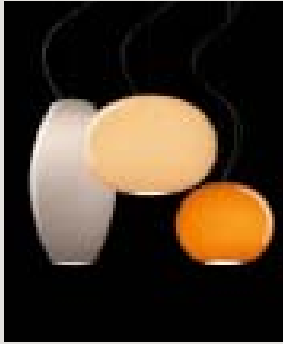

Lacquered aluminium

LED retrofit / Fluo
1x25W E27
Halo 1x150W E27

⊕ ⚡ CE IP 20

	energy cl.	colours	code	vat excluded
<i>New Buds 1</i>	A+, A, B, C	grigio	1780071 25	445,00
<i>New Buds 2</i>		avorio	1780072 50	479,00
<i>New Buds 3</i>		ambra	1780073 52	432,00
<i>New Buds 1 H. 5 m</i>		grigio	1780071 25SP5	487,00
<i>New Buds 2 H. 5 m</i>		avorio	1780072 50SP5	521,00
<i>New Buds 3 H. 5 m</i>		ambra	1780073 52SP5	474,00

Version without canopy with multiple canopy holder

<i>New Buds 1</i>	A+, A, B, C	grigio	1780071SR 25	425,00
<i>New Buds 2</i>		avorio	1780072SR 50	459,00
<i>New Buds 3</i>		ambra	1780073SR 52	412,00
<i>New Buds 1 H. 5 m</i>		grigio	1780071SR5 25	467,00
<i>New Buds 2 H. 5 m</i>		avorio	1780072SR5 50	501,00
<i>New Buds 3 H. 5 m</i>		ambra	1780073SR5 52	454,00

Spare parts:

<i>Glass New Buds 1</i>	grigio	178S001 25	279,00
<i>Glass New Buds 2</i>	avorio	178S002 50	313,00
<i>Glass New Buds 3</i>	ambra	178S003 52	266,00

Accessories:

<i>Decentralization kit</i> for steel cables	KIT DEC B	25,00
for steel cables + canopy	KIT DEC F	45,00
canopy for electrical dec.	KIT DEC M	79,00

Colours:

New Buds 1 grigio,
New Buds 2 avorio,
New Buds 3 ambra



Special colours
on request

Weight:

New Buds 1
net kg 3,20

New Buds 2
net kg 4,20

New Buds 3
net kg 3,20

Halo, Fluo, LED retrofit
light bulbs not included
→ specifications p. 170

Multiple canopy
→ specifications p. 100

Decentralization
→ specifications p. 106

New Buds 1



New Buds 2



New Buds 3

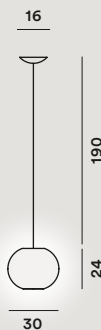

collection →

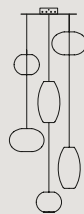

p. 102



080 Sospensione, *Suspension*

O-Space

Luca Nichetto
e Gianpietro Gai, 2003



Expanded polyurethane and
chrome metal

Halo 1x120W R7s

⊕ ⚡ CE IP 20

	energy cl.	colours	code	vat excluded
<i>O-Space</i>	C	bianco	127007 10	697,00
<i>O-Space H. 5 m</i>		bianco	127007 10/SP5	750,00

Spare parts:

<i>Protection glass</i>	bianco	PIREX94/3/I	18,00
<i>Protection disk</i>		PIREX D100/3I	28,00

Accessories:

<i>Decentralization kit</i> for steel cables		KIT DEC B	25,00
	for steel cables + canopy	KIT DEC F	45,00
	canopy for electrical dec.	KIT DEC M	79,00

Colours:
bianco



Special colours
on request

Weight:
net kg 4,40

Halo light bulbs
not included
→ specifications p. 170

Decentralization
→ specifications p. 106

Tecnico — 2016

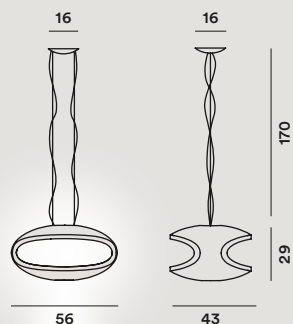

Planet

Changedesign, 2011



Polyethylene terephthalate
and nylon

Planet grande
LED retrofit / Fluo
1x25W E27
Halo 1x150W E27

Planet piccola
LED retrofit / Fluo
1x25WE27
Halo 1x105W E27



	energy cl.	colours	code	vat excluded
<i>Planet grande</i>	A+, A, B, C	bianco	223017 10	915,00
		rosso	223017 63	
<i>Planet grande H. 5 m</i>		bianco	223017SP5 10	939,00
		rosso	223017SP5 63	
<i>Planet piccola</i>	A+, A, B, C	bianco	223007 10	624,00
		rosso	223007 63	
<i>Planet piccola H. 5 m</i>		bianco	223007SP5 10	648,00
		rosso	223007SP5 63	
Spare parts:				
<i>Lampshade Planet grande</i>		bianco	223S001-R1 10	595,00
		rosso	223S001-R1 63	
<i>Lampshade Planet piccola</i>		bianco	223S00 10	304,00
		rosso	223S00 63	
Accessories:				
<i>Decentralization kit</i>	for steel cables		KIT DEC B	25,00
	for steel cables + canopy		KIT DEC F	45,00
	canopy for electrical dec.		KIT DEC M	79,00

Colours:
bianco, rosso



Weight:
Planet grande
net kg 2,50

Planet piccola
net kg 2,00

Halo, Fluo, LED retrofit
light bulbs not included
→ specifications p. 170

Decentralization
→ specifications p. 106

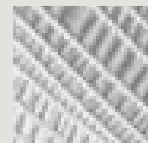
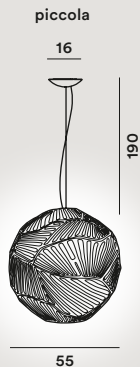
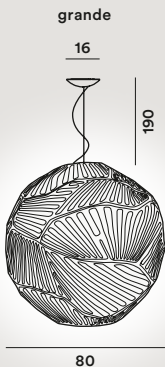

Plass grande

Luca Nichetto, 2011



Rotational moulded polycarbonate and aluminium

LED Included 30W 3000° K
2500 lm CRI>80 84 lm/W
+ 1x12W E27 PAR 30

Plass halogen
Halo 6x60W G9
+ 1x100W E27 PAR 30

Double switch



	energy cl.	colours	code	vat excluded
<i>Plass LED</i>	A+, A	grigio	2240071L 25	2.512,00
		azzurro	2240071L 30	
<i>Plass halogen</i>	C	grigio	2240071 25	2.103,00
		azzurro	2240071 30	
Spare parts:				
<i>Lampshade Plass</i>		grigio	224S001 25	978,00
		azzurro	224S001 30	
Accessories:				
<i>Decentralization kit</i>	for steel cables		KIT DEC B	25,00
	for steel cables + canopy		KIT DEC F	45,00
	canopy for electrical dec.		KIT DEC M	79,00

Colours:
grigio, azzurro

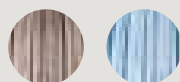

Special colours
on request

Weight:
net kg 23,00

Halo light bulbs not
included
→ specifications p. 170

Decentralization
→ specifications p. 106

Tecnico — 2016

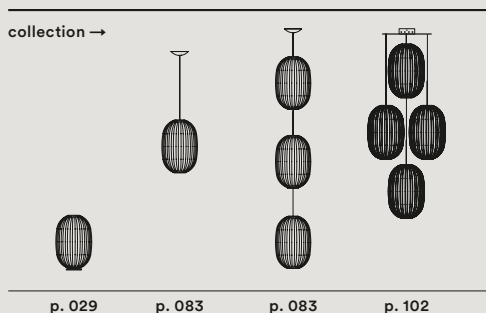
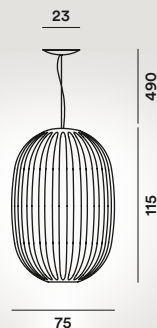

Plass media

Luca Nichetto, 2015



Rotational moulded
polycarbonate and steel

LED retrofit / Fluo
1x20W E27+1x8W GU10
Halo 1x116W E27
+ 1x75W GU10

⊕ ⊖ CE IP 20

doppia tripla quadrupla

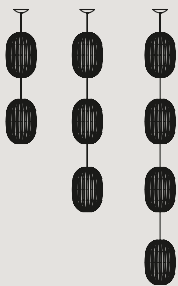

34

	energy cl.	colours	code	vat excluded
<i>Plass media E27+GU10</i>	A+, A, B, C	grigio	2240072 25	453,00
		azzurro	2240072 30	
<i>Plass media H. 5 m E27+GU10</i>	A+, A, B, C	grigio	2240072SP5 25	489,00
		azzurro	2240072SP5 30	
<i>Plass media 1 x E27</i>	A+, A, B, C	grigio	2240172 25	370,00
		azzurro	2240172 30	
<i>Plass media H. 5 m 1 x E27</i>	A+, A, B, C	grigio	2240172SP5 25	406,00
		azzurro	2240172SP5 30	
<i>Plass media doppia</i>		grigio	2240072/2 25	938,00
		azzurro	2240072/2 30	
<i>Plass media tripla</i>		grigio	2240072/3 25	1.345,00
		azzurro	2240072/3 30	
<i>Plass media quadrupla</i>		grigio	2240072/4 25	1.752,00
		azzurro	2240072/4 30	

Version without canopy with multiple canopy holder

<i>Plass media E27+GU10</i>	grigio	2240072SR 25	433,00
	azzurro	2240072SR 30	
<i>Plass media H. 5 m E27+GU10</i>	grigio	2240072SR5 25	469,00
	azzurro	2240072SR5 30	
<i>Plass media 1 x E27</i>	grigio	2240172SR 25	350,00
	azzurro	2240172SR 30	
<i>Plass media H. 5 m 1 x E27</i>	grigio	2240172SR5 25	386,00
	azzurro	2240172SR5 30	

Spare parts:

<i>Lampshade Plass media</i>	grigio	224S002 25	222,00
	azzurro	224S002 30	

Colours:
grigio, azzurro

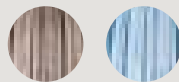

Special colours
on request

Weight:
net kg 3,50

Halo, Fluo LED retrofit
light bulbs not included
→ specifications p. 170

Multiple canopy
→ specifications p. 100

Decentralization
→ specifications p. 106

collection →



p. 029

p. 082

p. 102

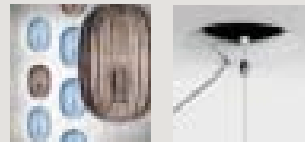

Rituals + Rituals xl

Ludovica e Roberto
Palomba, 2013-2015



Blown engraved satin glass
and lacquered metal

Rituals 1-2-3 E27
LED retrofit / Fluo
1x15W
Halo 1x70W

Rituals 1-2-3 halogen G9
Halo 1x60W

Rituals xl
LED retrofit / Fluo
1x25W E27
Halo 1x150W E27



	energy cl.	colours	code	vat excluded
<i>Rituals 1 E27</i>	A ⁺ , A, B, C	bianco	2440071E 10	356,00
<i>Rituals 1 G9</i>	C	bianco	2440071G 10	373,00
<i>Rituals 2 E27</i>	A ⁺ , A, B, C	bianco	2440072E 10	356,00
<i>Rituals 2 G9</i>	C	bianco	2440072G 10	373,00
<i>Rituals 3 E27</i>	A ⁺ , A, B, C	bianco	2440073E 10	301,00
<i>Rituals 3 G9</i>	C	bianco	2440073G 10	318,00
<i>Rituals 1 E27 H. 5 m</i>	A ⁺ , A, B, C	bianco	2440071ESP510	386,00
<i>Rituals 1 G9 H. 5 m</i>	C	bianco	2440071GSP510	403,00
<i>Rituals 2 E27 H. 5 m</i>	A ⁺ , A, B, C	bianco	2440072ESP510	386,00
<i>Rituals 2 G9 H. 5 m</i>	C	bianco	2440072GSP510	403,00
<i>Rituals 3 E27 H. 5 m</i>	A ⁺ , A, B, C	bianco	2440073ESP510	331,00
<i>Rituals 3 G9 H. 5 m</i>	C	bianco	2440073GSP510	348,00
<i>Rituals xl</i>	A ⁺ , A, B, C	bianco	2440074 10	496,00
<i>Rituals xl H. 5 m</i>	A ⁺ , A, B, C	bianco	2440074SP5 10	525,00

Colours: bianco



Weight:

Rituals 1
net kg 3,80

Rituals 2
net kg 4,00

Rituals 3
net kg 1,50

Rituals xl
net kg 5,90

Halo, Fluo, LED retrofit
light bulbs not included
→ specifications p. 170

Multiple canopy
→ specifications p. 100

Decentralization
→ specifications p. 106

Tecnico — 2016

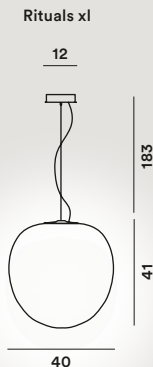
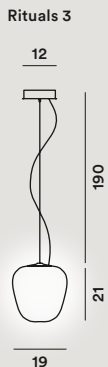
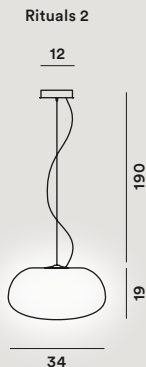

Version without canopy with multiple canopy holder

	energy cl.	colours	code	vat excluded
<i>Rituals 1 E27</i>	A ⁺ , A, B, C	bianco	2440071ESR 10	347,00
<i>Rituals 1 G9</i>	C	bianco	2440071GSR 10	364,00
<i>Rituals 2 E27</i>	A ⁺ , A, B, C	bianco	2440072ESR 10	347,00
<i>Rituals 2 G9</i>	C	bianco	2440072GSR 10	364,00
<i>Rituals 3 E27</i>	A ⁺ , A, B, C	bianco	2440073ESR 10	292,00
<i>Rituals 3 G9</i>	C	bianco	2440073GSR 10	309,00
<i>Rituals xl</i>	A ⁺ , A, B, C	bianco	2440074SR 10	487,00
<i>Rituals 1 E27 H. 5 m</i>	A ⁺ , A, B, C	bianco	2440071ESR510	377,00
<i>Rituals 1 G9 H. 5 m</i>	C	bianco	2440071GSR510	394,00
<i>Rituals 2 E27 H. 5 m</i>	A ⁺ , A, B, C	bianco	2440072ESR510	377,00
<i>Rituals 2 G9 H. 5 m</i>	C	bianco	2440072GSR510	394,00
<i>Rituals 3 E27 H. 5 m</i>	A ⁺ , A, B, C	bianco	2440073ESR510	322,00
<i>Rituals 3 G9 H. 5 m</i>	C	bianco	2440073GSR510	339,00
<i>Rituals xl H. 5 m</i>	A ⁺ , A, B, C	bianco	2440074SR5 10	516,00

Spare parts:

<i>Glass Rituals 1</i>	bianco	244S001 10	222,00
<i>Glass Rituals 2</i>	bianco	244S002 10	222,00
<i>Glass Rituals 3</i>	bianco	244S003 10	167,00
<i>Glass Rituals xl</i>	bianco	244S004 10	315,00

Accessories:

<i>Decentralization kit</i> for steel cables	KIT DEC B	25,00
for steel cables + canopy	KIT DEC F	45,00
canopy for electrical dec.	KIT DEC M	79,00

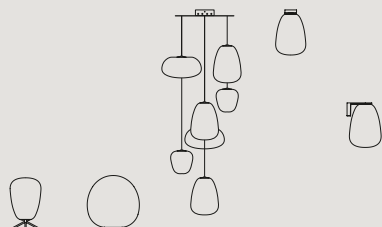
 collection →

p. 031

p. 031

p. 102

p. 123

p. 150



Spokes

Garcia Cumini, 2015

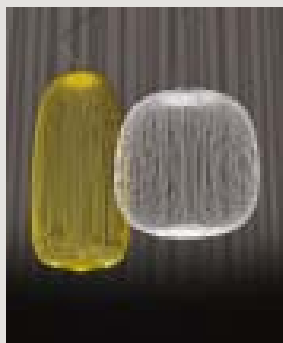

Varnished steel and aluminium

LED Included 38,5W 2700° K
2780 lm CRI>90 80 lm/W

Dimmable version
Possible configurations:
On-Off/Push/DALI



	energy cl.	colours	code	vat excluded
Spokes 1	A	bianco	2640071 10	855,00
		giallo	2640071 55	
Spokes 1 H. 5 m		bianco	2640071SP5 10	885,00
		giallo	2640071SP5 55	
Spokes 1 dimmable		bianco	2640071D 10	914,00
		giallo	2640071D 55	
Spokes 1 H. 5 m dimmable		bianco	2640071D5 10	944,00
		giallo	2640071D5 55	
Spokes 2	A	bianco	2640072 10	840,00
		giallo	2640072 55	
Spokes 2 H. 5 m		bianco	2640072SP5 10	870,00
		giallo	2640072SP5 55	
Spokes 2 dimmable		bianco	2640072D 10	899,00
		giallo	2640072D 55	
Spokes 2 H. 5 m dimmable		bianco	2640072D5 10	929,00
		giallo	2640072D5 55	
Accessories:				
Decentralization kit for steel cables			KIT DEC B	25,00

Colours:
bianco, giallo oro



Special colours
on request

Weight:
Spokes 1
net kg 4,40

Spokes 2
net kg 4,40

Decentralization
→ specifications p. 106

Tecnico — 2016

Spokes 1



Spokes 2

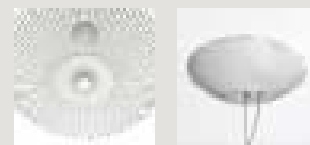
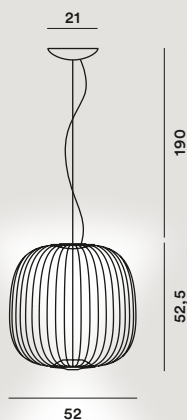

Supernova

Ferruccio Laviani, 2000



	energy cl.	colours	code	vat excluded
Supernova	A+, A, B, C	alluminio	102007 20	1.120,00
		fucsia	102007 66	
Supernova H. 5 m		alluminio	102007SP5 20	1.171,00
		fucsia	102007SP5 66	
Supernova xl	A+, A, B, C	alluminio	102007SP7 20	5.377,00
		on request	fucsia	

Accessories:

Decentralization kit for steel cables	KIT DEC B	25,00
for steel cables + canopy	KIT DEC F	45,00
canopy for electrical dec.	KIT DEC M	79,00

Lacquered aluminium

LED retrofit / Fluo
1x23W E27



Colours:
alluminio, fucsia

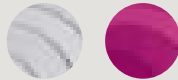

Special colours
on request

Weight:
Supernova
net kg 8,00

Supernova xl
net kg 19,50

Fluo, LED retrofit light
bulbs not included
→ specifications p. 170

Decentralization
→ specifications p. 106

Supernova

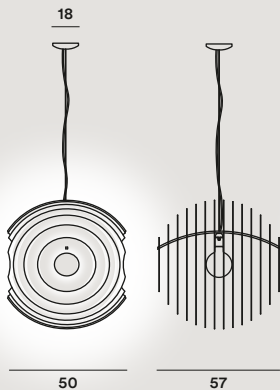

Supernova xl

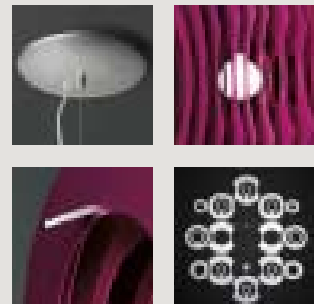
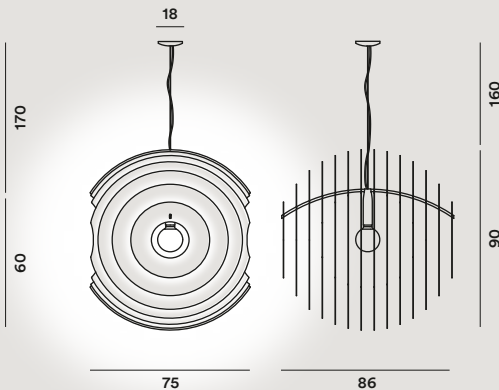

Tartan

Ludovica e Roberto
Palomba, 2015



Blown acid-etched glass
with reliefs

LED retrofit / Fluo
1x25W E27
Halo 1x150W E27

⊕ ⚡ CE IP 20

	energy cl.	colours	code	vat excluded
<i>Tartan</i>	A+, A, B, C	bianco	273007 10	408,00
<i>Tartan H. 5 m</i>		bianco	273007/5 10	437,00

Version without canopy with multiple canopy holder

<i>Tartan</i>		bianco	273007SR 10	398,00
<i>Tartan H. 5 m</i>		bianco	273007SR5 10	427,00

Spare parts:

<i>lampshade Tartan</i>			273S00 10	227,00
-------------------------	--	--	-----------	--------

Colours: bianco



Weight
net kg 4,60

Halo, Fluo, LED retrofit
light bulbs not included
→ specifications p. 170

Multiple canopy
→ specifications p. 100

Decentralization
→ specifications p. 106

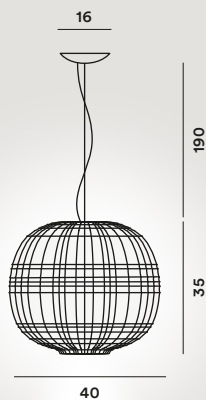

Tite

Marc Sadler, 2000



Fiberglass fabric with carbonium thread and nickel-plated steel

LED retrofit / Fluo
1x25W E27

Halo 1x116W E27

⊕ ⊖ CE IP 20

	energy cl.	colours	code	vat excluded
<i>Tite 1</i>	A ⁺ , A, B, C	nero	111017 20	477,00
<i>Tite 1 H. 5 m</i>		nero	111017SP5 20	503,00
<i>Tite 2</i>		nero	111027 20	370,00
<i>Tite 2 H. 5 m</i>		nero	111027SP5 20	396,00

Version without canopy with multiple canopy holder

<i>Tite 1</i>	A ⁺ , A, B, C	nero	111017SR 20	464,00
<i>Tite 1 H. 5 m</i>		nero	111017SR5 20	490,00
<i>Tite 2</i>		nero	111027SR 20	357,00
<i>Tite 2 H. 5 m</i>		nero	111027SR5 20	383,00

Spare parts:

<i>Lampshade Tite 1</i>	nero	111S001 20	343,00
<i>Lampshade Tite 2</i>	nero	111S002 20	245,00

Accessories:

<i>Decentralization kit</i> for power cable		KIT DEC C	33,00
canopy for electrical dec.		KIT DEC M	79,00

Colours: nero



Weight:

Tite 1
net kg 1,40

Tite 2
net kg 1,00

Halo, Fluo, LED retrofit
light bulbs not included
→ specifications p. 170

Multiple canopy
→ specifications p. 100

Decentralization
→ specifications p. 106

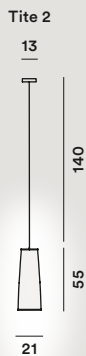

collection →

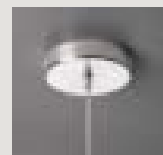

Tress

Marc Sadler, 2009



Coated fibreglass-based composite material and chromed metal

Tress media / *Tress piccola*
LED retrofit / Fluo
1x12W E27 PAR 30
Halo 1x100W E27 PAR 30

Tress mini
LED retrofit / Fluo
1x8W GU10 PAR 16
Halo 1x75W GU10 PAR 20



	energy cl.	colours	code	vat excluded
<i>Tress media</i>	A ⁺ , A, B, C	bianco	182017 10	642,00
		nero	182017 20	
		cremisi	182017 67	
		greige	182017 25	
		indaco	182017 87	
<i>Tress media H. 5 m</i>		bianco	182017SP5 10	670,00
		nero	182017SP5 20	
		cremisi	182017SP5 67	
		greige	182017SP5 25	
		indaco	182017SP5 87	
<i>Tress piccola</i>	A ⁺ , A, B, C	bianco	182027 10	468,00
		nero	182027 20	
		cremisi	182027 67	
		greige	182027 25	
		indaco	182027 87	
<i>Tress piccola H. 5 m</i>		bianco	182027SP5 10	496,00
		nero	182027SP5 20	
		cremisi	182027SP5 67	
		greige	182027SP5 25	
		indaco	182027SP5 87	
<i>Tress mini</i>	A ⁺ , A, B, C	bianco	182037 10	393,00
		nero	182037 20	
		cremisi	182037 67	
		greige	182037 25	
		indaco	182037 87	
<i>Tress mini H. 5 m</i>		bianco	182037SP5 10	418,00
		nero	182037SP5 20	
		cremisi	182037SP5 67	
		greige	182037SP5 25	
		indaco	182037SP5 87	

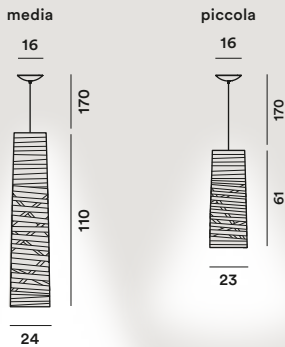

Colours: bianco, nero, cremisi, greige, indaco

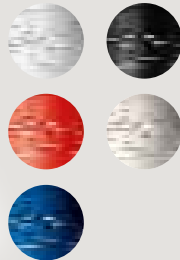

Weight:

Tress media
net kg 2,40

Tress piccola
net kg 1,60

Tress mini
net kg 1,10

Halo, Fluo, LED retrofit light bulbs not included
→ specifications p. 170

Multiple canopy
→ specifications p. 100

Decentralization
→ specifications p. 106



collection →

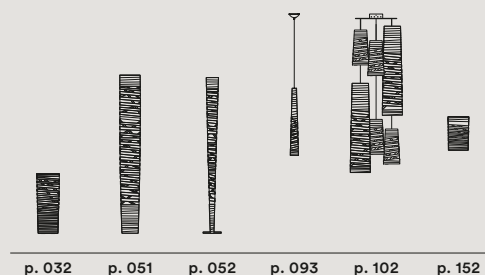

media/grande



piccola



Version without canopy with multiple canopy holder	energy cl.	colours	code	vat excluded	
Tress media	A ⁺ , A, B, C	bianco	182017SR 10	622,00	
		nero	182017SR 20		
		cremisi	182017SR 67		
		greige	182017SR 25		
		indaco	182017SR 87		
Tress media H. 5 m		bianco	182017SR5 10	650,00	
		nero	182017SR5 20		
		cremisi	182017SR5 67		
		greige	182017SR5 25		
		indaco	182017SR5 87		
Tress piccola	A ⁺ , A, B, C	bianco	182027SR 10	448,00	
		nero	182027SR 20		
		cremisi	182027SR 67		
		greige	182027SR 25		
		indaco	182027SR 87		
Tress piccola H. 5 m		bianco	182027SR5 10	476,00	
		nero	182027SR5 20		
		cremisi	182027SR5 67		
		greige	182027SR5 25		
		indaco	182027SR5 87		
Tress mini	A ⁺ , A, B, C	bianco	182037SR 10	380,00	
		nero	182037SR 20		
		cremisi	182037SR 67		
		greige	182037SR 25		
		indaco	182037SR 87		
Tress mini H. 5 m		bianco	182037SR5 10	405,00	
		nero	182037SR5 20		
		cremisi	182037SR5 67		
		greige	182037SR5 25		
		indaco	182037SR5 87		
Spare parts:		Lampshade Tress media	bianco 182S02 10	477,00	
			nero 182S02 20		
			cremisi 182S02 67		
			greige 182S02 25		
			indaco 182S02 87		
		Lampshade Tress piccola	bianco 182S01 10	303,00	
			nero 182S01 20		
			cremisi 182S01 67		
			greige 182S01 25		
			indaco 182S01 87		
		Lampshade Tress mini	bianco 182S0012 10	280,00	
			nero 182S0012 20		
			cremisi 182S0012 67		
			greige 182S0012 25		
			indaco 182S0012 87		
Accessories:		Decentralization kit for steel cables	KIT DEC B	25,00	
			for steel cables + canopy	KIT DEC F	45,00
			for power cable	KIT DEC C	33,00
			canopy for electrical dec.	KIT DEC M	79,00

Special colours
on request

Tress grande

Marc Sadler, 2009



Coated fibreglass-based composite material, chromed metal and aluminium

Tress grande LED Included
35W 3000°K
3062 lm CRI > 90 88 lm/W

Dimmable LED version
Possible configurations:
On-Off/Push/DALI

Tress grande halogen
Halo 1x160W R7s



	energy cl.	colours	code	vat excluded
<i>Tress grande LED</i>	A+	bianco	182007L 10	1.180,00
		nero	182007L 20	
		cremisi	182007L 67	
		greige	182007L 25	
		indaco	182007L 87	
<i>Tress grande LED dimmable</i>	A+	bianco	182007LD 10	1.247,00
		nero	182007LD 20	
		cremisi	182007LD 67	
		greige	182007LD 25	
		indaco	182007LD 87	
<i>Tress grande LED H. 5 m</i>		bianco	182007LSP5 10	1.227,00
		nero	182007LSP5 20	
		cremisi	182007LSP5 67	
		greige	182007LSP5 25	
		indaco	182007LSP5 87	
<i>Tress grande LED H. 5 m dimmable</i>		bianco	182007LD5 10	1.294,00
		nero	182007LD5 20	
		cremisi	182007LD5 67	
		greige	182007LD5 25	
		indaco	182007LD5 87	
<i>Tress grande halogen</i>	C	bianco	182007 10	766,00
		nero	182007 20	
		cremisi	182007 67	
		greige	182007 25	
		indaco	182007 87	
<i>Tress grande halogen H. 5 m</i>		bianco	182007SP5 10	818,00
		nero	182007SP5 20	
		cremisi	182007SP5 67	
		greige	182007SP5 25	
		indaco	182007SP5 87	
Spare parts:				
<i>Lampshade Tress grande</i>		bianco	182S04 10	462,00
		nero	182S04 20	
		cremisi	182S04 63	
		greige	182S04 63	
		indaco	182S04 63	
Accessories:				
<i>Decentralization kit</i> for steel cables			KIT DEC B	25,00

Colours: bianco, nero, cremisi, greige, indaco

Weight:
LED net kg 3,10

Halo light bulbs not included
→ specifications p. 170

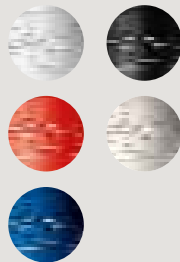

Special colours on request

Halogen net kg 3,90

Decentralization → specifications p. 106

collection →

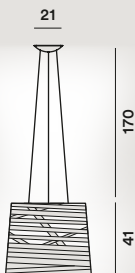
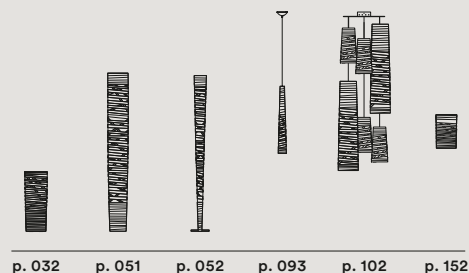

Tress Stilo

Marc Sadler, 2011

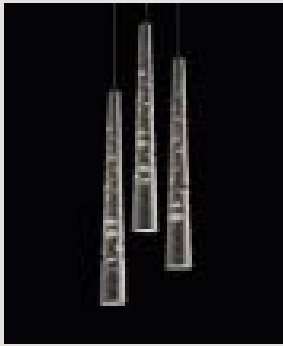

Coated fibreglass-based composite material, stainless steel and polycarbonate

LED retrofit
1x8W GU10 PAR 16
Halo 1x35W PAR 16

⊕ ⊖ CE IP 20

	energy cl.	colours	code	vat excluded
<i>Tress Stilo</i>	A ⁺ , A ⁺ , A, B, C	bianco	182047 10	310,00
		nero	182047 20	
<i>Tress Stilo H. 5 m</i>		bianco	182047SP5 10	335,00
		nero	182047SP5 20	

Version without canopy with multiple canopy holder

<i>Tress Stilo</i>	A ⁺ , A ⁺ , A, B, C	bianco	182047SR 10	301,00
		nero	182047SR 20	
<i>Tress Stilo H. 5 m</i>		bianco	182047SR5 10	326,00
		nero	182047SR5 20	

Accessories:

<i>Decentralization kit</i> for power cable	KIT DEC C	33,00
canopy for electrical dec.	KIT DEC M	79,00

Colours:
bianco, nero, rosso

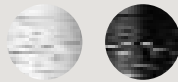

Special colours
on request

Weight:
net kg 0,50

Halo, LED retrofit light
bulbs not included
→ specifications p. 170

Multiple canopy
→ specifications p. 100

Decentralization
→ specifications p. 106



collection →

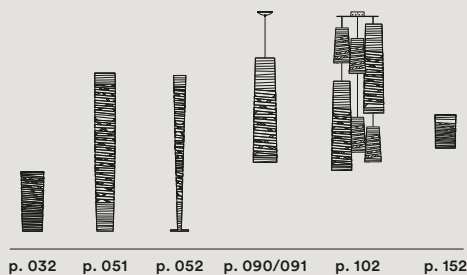

p. 032 p. 051 p. 052 p. 090/091 p. 102 p. 152



Troag

Luca Nichetto, 2010



Curved plywood and PMMA

Troag grande
Fluo 1x80W G5

Troag media
Fluo 1x54W G5

Troag piccola
Fluo 1x24W G5



	energy cl.	colours	code	vat excluded
<i>Troag grande</i>	A+, A	bianco	2050071 10	899,00
		nero	2050071 20	
		naturale	2050071 50	
<i>Troag media</i>	A+, A	bianco	205007 10	724,00
		nero	205007 20	
		naturale	205007 50	
<i>Troag media H. 5 m</i>	A+, A	bianco	205007SP5 10	755,00
		nero	205007SP5 20	
		naturale	205007SP5 50	
<i>Troag piccola</i>	A+, A	bianco	2050072 10	620,00
		nero	2050072 20	
		naturale	2050072 50	
<i>Troag piccola H. 5 m</i>	A+, A	bianco	2050072SP5 10	650,00
		nero	2050072SP5 20	
		naturale	2050072SP5 50	

Accessories:

<i>Decentralization kit</i> canopy for electrical dec.	KIT DEC M	79,00
--	-----------	-------

Colours: bianco,
nero, naturale

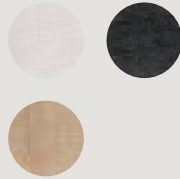

Special colours
on request

Weight:

Troag grande
net kg 3,50

Troag media
net kg 2,80

Troag piccola
net kg 1,80

Fluo light bulbs

not included
→ specifications p. 170

Decentralization
→ specifications p. 106

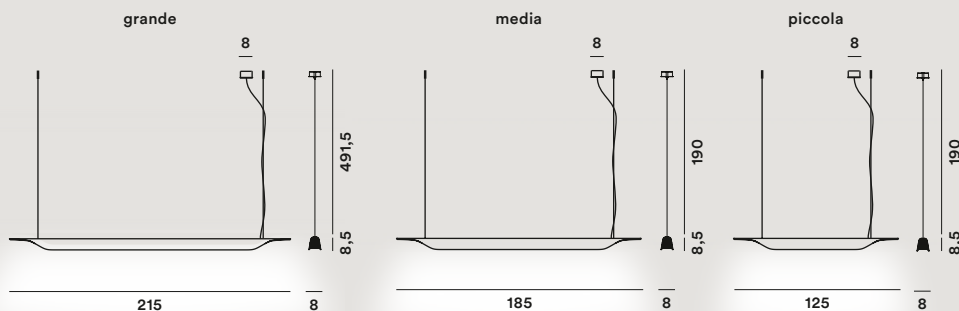

Tropico

Giulio Iacchetti, 2008



Injection moulded polycarbonate and chromed metal

Tropico Vertical

Fluo 1x40W max 2G11
Multiwatt electronic ballast
24/36/40

Tropico Sphera

Fluo 1x42W max GX24q-4
Multiwatt electronic ballast
26/32/42

Tropico Ellipse

Fluo 1x42W max GX24q-4
Multiwatt electronic ballast
26/32/42

⊕ ⊖ CE IP 20

	energy cl.	colours	code	vat excluded
<i>Tropico Vertical</i>	A ⁺ , A	ghiaccio	179072 16	1.113,00
		avorio	179072 50	
<i>Tropico Sphera</i>	A ⁺ , A	ghiaccio	179073 16	977,00
		avorio	179073 50	
<i>Tropico Ellipse</i>	A ⁺ , A	ghiaccio	179074 16	910,00
		avorio	179074 50	
<i>Tropico Vertical H. 5 m</i>		ghiaccio	179072 16 SP5	1.138,00
		avorio	179072 50 SP5	
<i>Tropico Sphera H. 5 m</i>		ghiaccio	179073 16 SP5	1.002,00
		avorio	179073 50 SP5	
<i>Tropico Ellipse H. 5 m</i>		ghiaccio	179074 16 SP5	935,00
		avorio	179074 50 SP5	

Spare parts:

<i>Set Tropico Vertical</i>	ghiaccio	179S002 16	332,00
	avorio	179S002 50	
<i>Set Tropico Sphera</i>	ghiaccio	179S003 16	338,00
	avorio	179S003 50	
<i>Set Tropico Ellipse</i>	ghiaccio	179S004 16	304,00
	avorio	179S004 50	

Accessories:

<i>Set colour filters Tropico Vertical</i>	blu/arancio	179S172-R1	160,00
<i>Set colour filters Tropico Sphera</i>	blu/arancio	179S173-R1	76,00
<i>Set colour filters Tropico Ellipse</i>	blu/arancio	179S174-R1	68,00
<i>Decentralization kit</i> for steel cables		KIT DEC B	25,00
	for steel cables + canopy	KIT DEC F	45,00
	canopy for electrical dec.	KIT DEC M	79,00

Colours:
ghiaccio, avorio

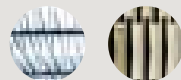

Weight:
Tropico Vertical
net kg 7,70

Tropico Sphera
net kg 6,50

Tropico Ellipse
net kg 6,50

Fluo light bulbs
not included
→ specifications p. 170

Decentralization
→ specifications p. 106

Vertical

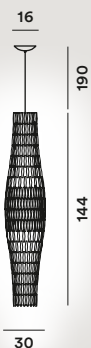

Sphera

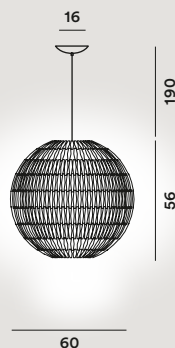

Ellipse

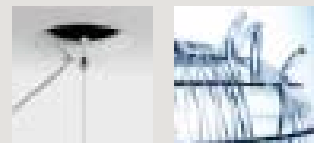
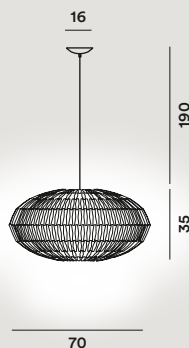

Twiggy

Marc Sadler, 2007



Coated fibreglass-based composite material, PMMA, and polycarbonate

LED retrofit / Fluo
3x20W E27
Halo 3x77W E27



	energy cl.	colours	code	vat excluded
<i>Twiggy grande</i>	A+, A, B, C	bianco	159007 10	687,00
		nero	159007 20	
<i>Twiggy grande H. 5 m</i>		bianco	159007 10SP5	689,00
		nero	159007 20SP5	
Spare parts:				
<i>Lampshade Twiggy grande</i>		bianco	159S10 10	464,00
		nero	159S10 20	
<i>Lower diffusor disk</i>			159R05	29,00
Accessories:				
<i>Decentralization kit</i>	for power cable		KIT DEC C	33,00
	canopy for electrical dec.		KIT DEC M	

Colours:
bianco, nero



Special colours
on request

Weight:
net kg 1,80

Halo, Fluo, LED retrofit
light bulbs not included
→ specifications p. 170

Decentralization
→ specifications p. 106

Tecnico — 2016

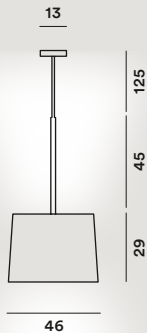

collection →

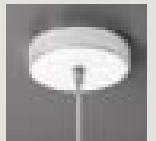
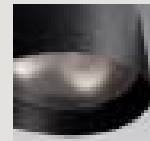
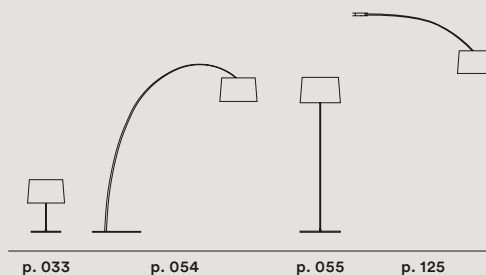

Uto

Lagranja Design, 2005

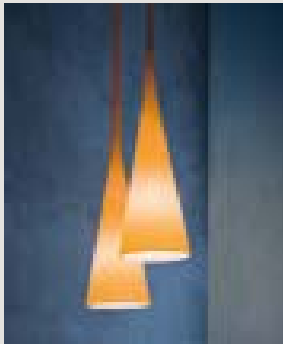

	energy cl.	colours	code	vat excluded
Uto	A ⁺ , A	bianco	142000 10	319,00
		giallo	142000 50	
		arancio	142000 53	

Thermoplastic elastomer and polycarbonate

LED retrofit / Fluo
1x15W E27
Switch inside the flexible tube



Colours: bianco, giallo, arancio

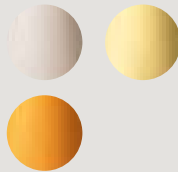

Special colours on request

Weight:
net kg 2,00

Fluo, LED retrofit light bulbs not included
→ specifications p. 170

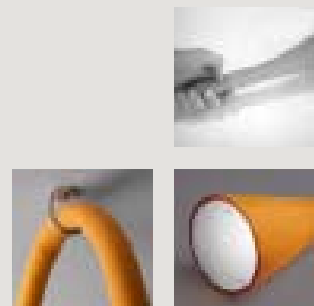
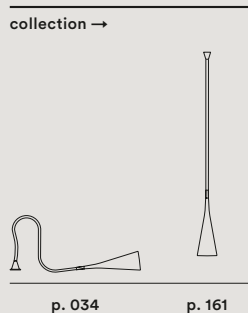
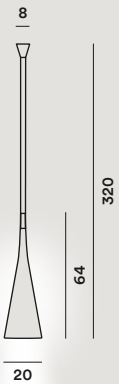

Wave

Studio Baruffi & De Santi,
2009



	energy cl.	colours	code	vat excluded
Wave	C	bianco	185007 10	1.050,00
		alluminio	185007 77	
Wave H. 5 m	C	bianco	185007SP5 10	1.086,00
		alluminio	185007SP5 77	
Accessories:				
Decentralization kit	canopy for electrical dec.		KIT DEC M	79,00

Lacquered aluminium

Halo 3x80W R7s

⊕ ⚡ CE IP 20

Colours:
bianco, alluminio



Special colours
on request

Weight:
net kg 6,00

Halo light bulbs
not included
→ specifications p. 170

Tecnico — 2016

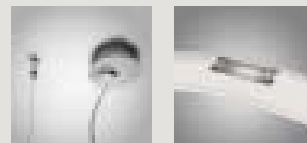
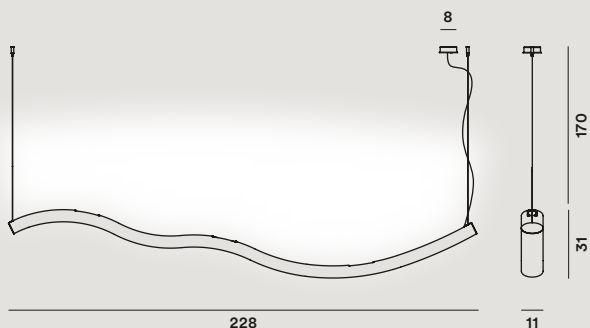

Accessori, Accessories

100 **Rosoni multipli**

104 **Rosone lineare**

102 **Rosone tondo**

106 **Kit decentramento**

Multiple canopies



Round multiple canopy

Colour: white
Laquered metal

Weight: net kg 9,00

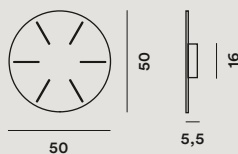

code: ROSONE01 10

vat excluded

415,00



Linear multiple canopy 90 cm

Colour: white
Laquered metal

Weight: net kg 7,00

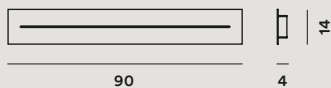

code: ROSONE02 10

vat excluded

349,00



Linear multiple canopy 135 cm

Colour: white
Laquered metal

Weight: net kg 10,00

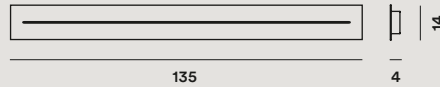

code: ROSONE03 10

vat excluded

464,00

Max refers
to installation
in staggered
composition

Model	round	linear 90	linear 135
<i>Aplomb - Aplomb mini</i>	max 9	max 6	max 9
<i>Birdie grande</i>	max 6	max 6	max 9
<i>Birdie piccola</i>	max 9	max 6	max 9
<i>Caboche piccola</i>	max 6	max 5	max 8
<i>Caiigo</i>	max 6	max 6	max 9
<i>Chouchin 1</i>	max 6	max 4	max 6
<i>Chouchin 2</i>	max 6	max 6	max 9
<i>Chouchin 3</i>	max 6	max 5	max 8
<i>Chouchin mini 1 - 2</i>	max 9	max 6	max 9
<i>Gregg media</i>	max 6	max 5	max 8
<i>Gregg piccola</i>	max 9	max 6	max 9
<i>Havana</i>	max 6	max 6	max 9
<i>Maki</i>	max 9	max 6	max 9
<i>New Buds 1</i>	max 6	max 6	max 9
<i>New Buds 2</i>	max 6	max 4	max 6
<i>New Buds 3</i>	max 6	max 5	max 8
<i>Plass media</i>	max 6	max 5	max 8
<i>Rituals 1</i>	max 6	max 6	max 9
<i>Rituals 2</i>	max 6	max 5	max 7
<i>Rituals 3</i>	max 9	max 6	max 9
<i>Rituals xl</i>	max 5	max 4	max 5
<i>Tartan</i>	max 5	max 4	max 5
<i>Tite 1 - Tite 2</i>	max 9	max 6	max 9
<i>Tress media - Tress piccola</i>	max 6	max 6	max 9
<i>Tress mini - Tress Stilo</i>	max 9	max 6	max 9

Round multiple canopy

Aplomb + Aplomb mini

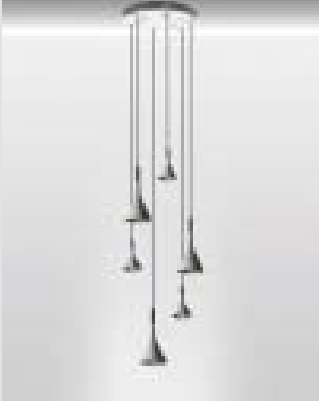

Birdie



Caboche piccola

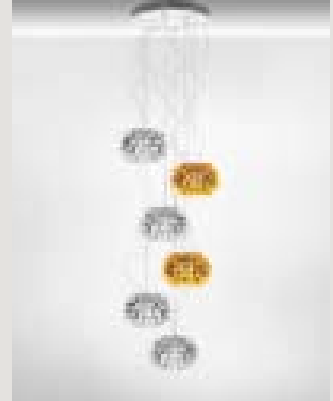

Chouchin + Chouchin mini



Gregg



Havana



Round multiple canopy

Maki



Plass media

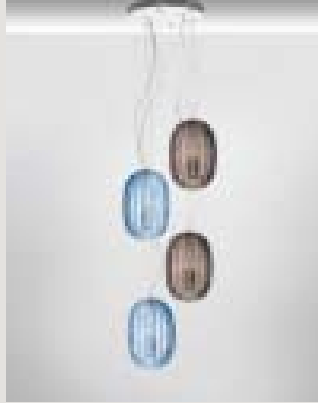

New Buds

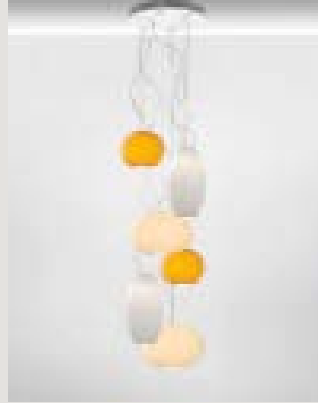

Tartan



Tite 2

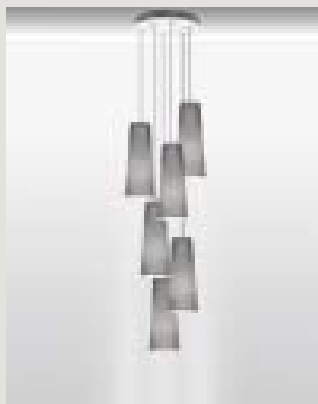

Tress Stilo



Linear multiple canopy

Aplomb + Aplomb mini



Birdie



Caboche piccola



Chouchin + Chouchin mini

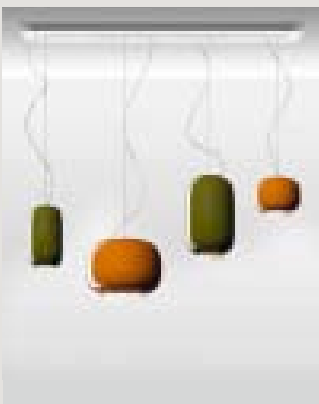

Gregg

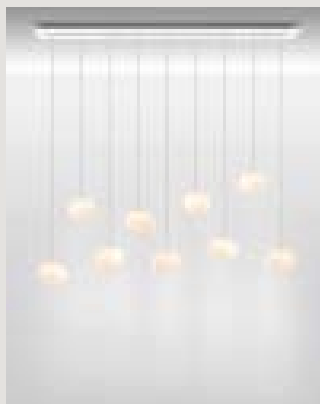

Maki



Linear multiple canopy

Rituals



Tartan



Tress



Tite 2



Decentralization kit



Kit B — Code: KIT DEC B

Decentralization for steel cable support, includes 3 steel cable.

For the models: Allegretto, Allegro, Behive, Big Bang, Caboche, Caiigo, Chouchin, Chouchin Reverse, Chouchin mini, Gregg grande / media, Le Soleil, New Buds, O-Space, Planet, Plass, Plass media, Rituals, Rituals XL, Spokes, Supernova, Tartan, Tropico, Tress grande / media / piccola.

Weight: net kg 0,01

	<u>vat excluded</u>
	25,00

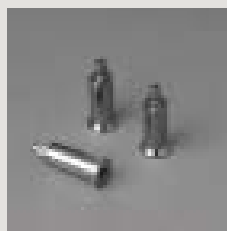

Kit C — Code: KIT DEC C

Decentralization for power cable.

For the models: Aplomb, Aplomb mini, Birdie, Giga-Lite, Gregg piccola, Havana, Maki, Tite, Tress mini, Tress stilo, Twiggy.

Weight: net kg 0,01

	<u>vat excluded</u>
	33,00





Kit F — Code: KIT DEC F   

Decentralization for steel cable support, includes 3 steel cable support and a white canopy.

For the models: Allegretto, Allegro, Behive, Big Bang (LED version excluded), Caboche (LED version excluded), Chouchin, Chouchin Reverse, Chouchin mini, Gregg grande /media, Le Soleil, New Buds, O-Space, Planet, Plass, Plass media, Rituals, Supernova, Tartan, Tropico, Tress grande (LED version excluded) / media / piccola.

Weight: net kg 0,03

vat excluded

45,00

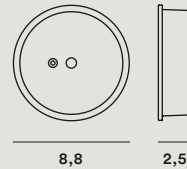

Kit M — Code: KIT DEC M   

Canopy electrical decentralization up to 4 lamps.

The kit M contains only the canopy, to compositions as picture order the necessary quantity of Kit B or Kit C.

For the models: Aplomb, Behive, Big Bang (LED version excluded), Caboche (LED version excluded), Chouchin, Chouchin Reverse, Chouchin mini, Giga-Lite, Gregg, Havana, Jamaica, Le Soleil, Maki, New Buds, O-Space, Planet, Plass, Plass media, Rituals, Rituals XL, Supernova, Tite, Tress (LED version excluded), Tress Stilo, Troag, Tropico, Twiggy, Wave.

Weight: net kg 0,01

vat excluded

79,00

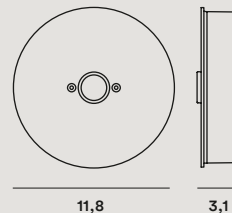



Soffitto, Ceiling

- 110 **Bahia +
Bahia mini**
- 111 **Big Bang**
- 112 **Birdie**
- 114 **Blob S**
- 115 **Caboche**
- 116 **Circus**
- 117 **Ellepi**
- 118 **Falena**

- 119 **Folio**
- 120 **Gregg**
- 121 **Lumiere
xxl + xxs**
- 122 **Nuage**
- 123 **Rituals**
- 124 **Tivu**
- 125 **Twiggy**

Bahia + Bahia mini

Lucidi e Pevere, 2010-2015



	energy cl.	colours	code	vat excluded
<i>Bahia fluo</i>	A ⁺ , A	bianco	196005 10	445,00
<i>Bahia mini fluo</i>	A ⁺ , A	bianco	1960052 10	248,00
<i>Bahia mini fluo dimmable</i>	A ⁺ , A	bianco	1960052D 10	294,00
<i>Bahia mini LED</i>	A ⁺	bianco	1960052L 10	399,00
<i>Bahia mini LED dimmable</i>	A ⁺	bianco	1960052LD 10	450,00

Injection moulded polycarbonate

Bahia fluo
1x40W + 1x22W 2GX13

Bahia mini
LED included 21W 2850° K
2425 lm CRI>90 115 lm/W
Dimmable LED version
Possible configurations:
On-Off/Push/DALI

Fluo 1x22W 2GX13

Dimmable Fluo version
on request
Possible configurations:
On-Off/Push/DALI



Colours: bianco



Weight:
Bahia
net kg 3,40

Bahia mini
net kg 2,00

Fluo light bulbs
not included
→ specifications p. 170

Tecnico — 2016

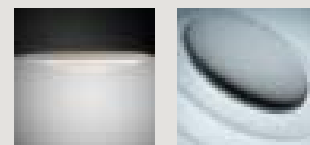
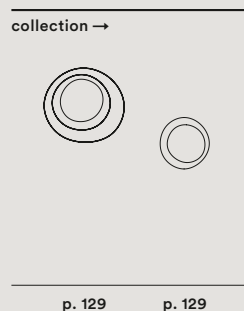
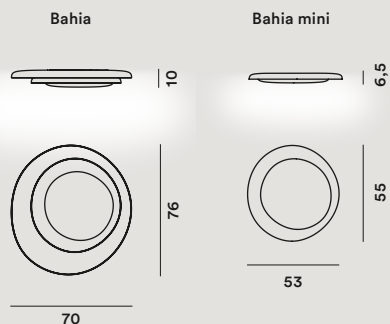

Big Bang

Enrico Franzolini con
Vicente Garcia Jimenez, 2005



	energy cl.	colours	code	vat excluded
<i>Big Bang</i>	C	bianco	151005 10	429,00
		rosso	151005 63	445,00
Spare parts:				
<i>Set lampshades Big Bang</i>		bianco	151S05 10	254,00
		rosso	151S05 63	270,00
<i>Halogen protection glass</i>			PIREX94/4/I	18,00

Methacrylate and coated
metal

Halo 1x120W R7s



Colours:
bianco, rosso

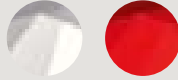

Special colours
on request

Weight:
net kg 3,00

Halo light bulbs
not included
→ specifications p. 170

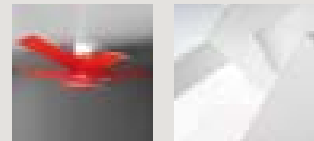
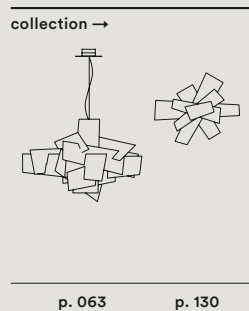
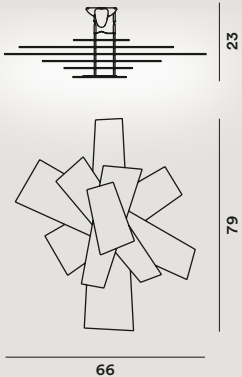

Birdie

Ludovica e Roberto
Palomba, 2012



Polycarbonate and coated aluminium

LED retrofit / Fluo
1-3-6-9x20W E27
Halo 1-3-6-9x70W E27

Different heights on request

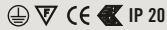

	energy cl.	colours	code	vat excluded
Birdie 1	A ⁺ , A, B, C	bianco	2210081 10	326,00
		grigio	2210081 25	
		arancio	2210081 53	
		amaranto	2210081 65	
Birdie 3	A ⁺ , A, B, C	bianco	2210083 10	718,00
		grigio	2210083 25	
		arancio	2210083 53	
		amaranto	2210083 65	
Birdie 6	A ⁺ , A, B, C	bianco	2210086 10	1.350,00
		grigio	2210086 25	
		arancio	2210086 53	
		amaranto	2210086 65	
Birdie 9	A ⁺ , A, B, C	bianco	2210089 10	1.997,00
		grigio	2210089 25	
		arancio	2210089 53	
		amaranto	2210089 65	
Spare parts:				
Lampshade Birdie		bianco	221S002 10	46,00
		grigio	221S002 25	
		arancio	221S002 53	
		amaranto	221S002 65	

Colours: bianco, grigio, arancio, amaranto



Special colours on request

Weight:
Birdie 1
net kg 1,50

Birdie 3
net kg 3,70

Birdie 6
net kg 6,60

Birdie 9
net kg 9,50

Halo, Fluo, LED retrofit light bulbs not included → specifications p. 170

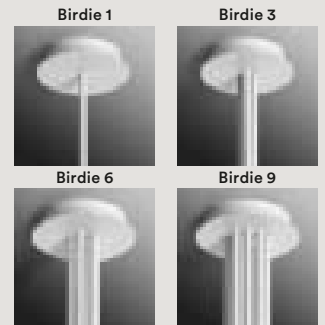
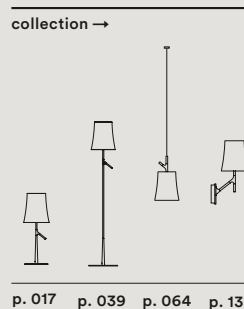
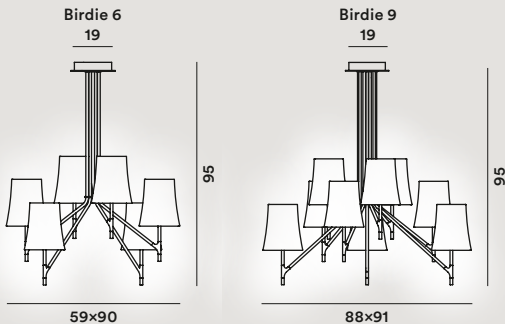
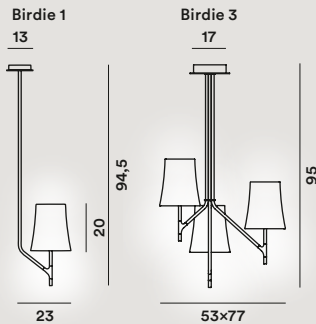

Birdie

Ludovica e Roberto
Palomba, 2013

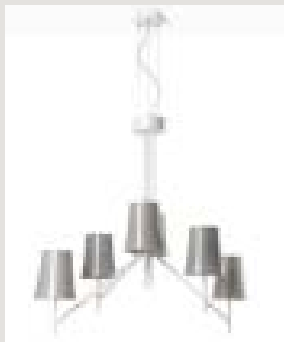

Polycarbonate and coated aluminium

LED retrofit / Fluo
6-9x20W E27
Halo 6-9x60W E27



	energy cl.	colours	code	vat excluded
Birdie 6 with cables	A ⁺ , A, B, C	bianco	2210076 10	1.476,00
		grigio	2210076 25	
		arancio	2210076 53	
		amaranto	2210076 65	
Birdie 6 H. 5 m with cables		bianco	2210076SP5 10	1.512,00
		grigio	2210076SP5 25	
		arancio	2210076SP5 53	
		amaranto	2210076SP5 65	
Birdie 9 with cables	A ⁺ , A, B, C	bianco	2210079 10	2.124,00
		grigio	2210079 25	
		arancio	2210079 53	
		amaranto	2210079 65	
Birdie 9 H. 5 m with cables		bianco	2210079SP5 10	2.160,00
		grigio	2210079SP5 25	
		arancio	2210079SP5 53	
		amaranto	2210079SP5 65	
Spare parts:				
Lampshade Birdie		bianco	221S002 10	46,00
		grigio	221S002 25	
		arancio	221S002 53	
		amaranto	221S002 65	

Colours: bianco, grigio, arancio, amaranto



Special colours on request

Weight:
Birdie 6
net kg 6,60

Birdie 9
net kg 9,50

Halo, Fluo, LED retrofit light bulbs not included
→ specifications p. 170

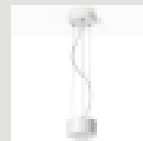
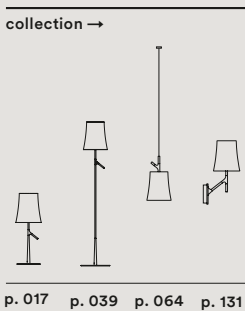
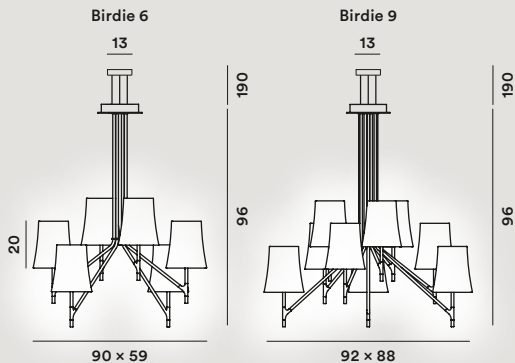

Blob S

Karim Rashid, 2002



	energy cl.	colours	code	vat excluded
<i>Blob S</i>	A ⁺ , A	bianco	124035 10	185,00
Spare parts:				
<i>Lampshade Blob S</i>		bianco	124S00 10	62,00

Rotational moulded polyethylene and coated metal

Fluo 1x24W 2G11

☐ ▽ CE IP 20

Colours: bianco



Weight:
net kg 1,10

Fluo light bulbs not included
→ specifications p. 170

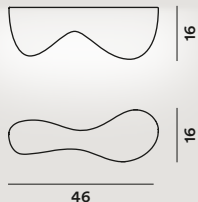

collection →



Caboche

Patricia Urquiola con
Elia Gerotto, 2006

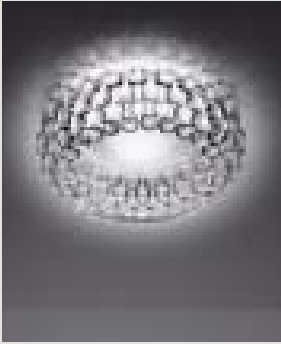

	energy cl.	colours	code	vat excluded
Caboche	C	trasparente	138008 16	773,00
		giallo oro	138008 52	
Spare parts:				277,00
Set sphere Caboche		trasparente	138S008 16	
		giallo oro	138S008 52	
Kit 15 prongs 3 sphere Caboche			138KIT 15M3	26,00
Kit 15 prongs 4 sphere Caboche			138KIT 15S4	26,00
Kit 3+3 prongs 3 + 4 sphere Caboche			138KIT3-R2	18,00
Glass Caboche			138V018/1	82,00
Halogen protection glass			PIREX138/2S4I	18,00

PMMA, blown glass and
chromed metal

Halo 1x120W R7s



Colours:
trasparente, giallo oro

Weight:
net kg 9,10

Halo light bulbs not
included
→ specifications p. 170

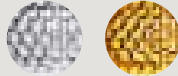

Special colours
on request

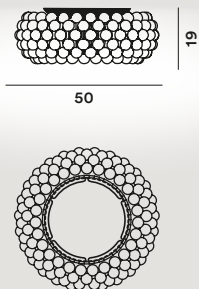

collection →

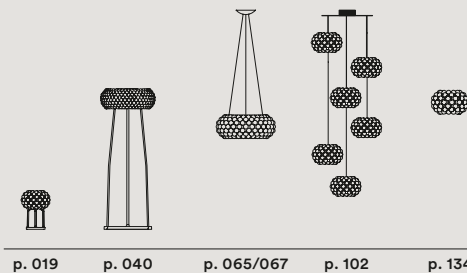

Circus

Defne Koz, 1994



	energy cl.	colours	code	vat excluded
<i>Circus grande</i>	A ⁺ , A, B, C	bianco	0460081 11	420,00
<i>Circus piccola</i>	A ⁺ , A, B, C	bianco	046008 11	267,00

Spare parts:

<i>Glass Circus grande</i>	bianco	046S001 11	270,00
<i>Glass Circus piccola</i>	bianco	046S00 11	150,00

Blown glass, nickel-plated or coated metal

Circus grande
LED retrofit / Fluo
4x12W E27
Halo 4x46W E27

Circus piccola
LED retrofit / Fluo
4x8W E14
Halo 4x30W E14



Colours: bianco



Special colours on request

Weight:
Circus grande
net kg 4,70

Circus piccola
net kg 2,10

Halo, Fluo, LED retrofit light bulbs not included
→ specifications p. 170

grande

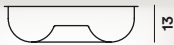

46

piccola



32

collection →



p. 135



Ellepi

Alessandra Matilde, 2003

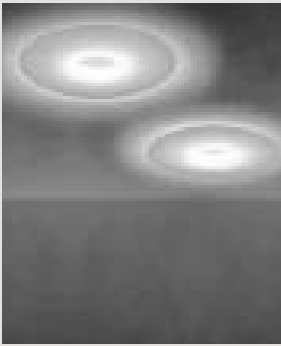

Methacrylate and coated
metal

Fluo 1x55W 2GX13



	energy cl.	colours	code	vat excluded
<i>Ellepi</i>	A ⁺ , A	bianco	128005 10	399,00
Spare parts:				
<i>Lampshade Ellepi</i>		bianco	128S00 10	206,00

Colours: bianco



Special colours
on request

Weight:
net kg 4,30

Fluo light bulbs
not included
→ specifications p. 170



6,5

collection →

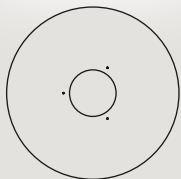

74



p. 137

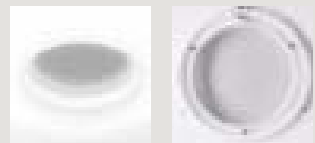

Falena

Lucidi e Pevere, 2011

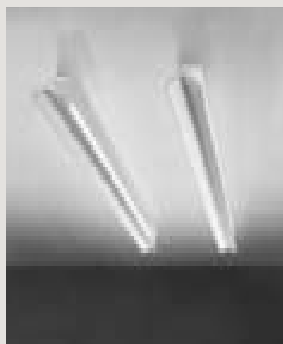

	energy cl.	colours	code	vat excluded
<i>Falena 2</i>	A ⁺ , A	bianco	215005F2 10	391,00
<i>Falena 3</i>	A ⁺ , A	bianco	215005F3 10	515,00
<i>Falena 2 dimmable</i>	A ⁺ , A	bianco	215005F2DM 10	476,00
<i>Falena 3 dimmable</i>	A ⁺ , A	bianco	215005F3DM 10	601,00

Coated aluminium and polycarbonate

Falena 2
Fluo 1x24W G5

Falena 3
Fluo 1x54W G5
Dimmable version
Possible configurations:
On-Off/Push/DALI



Colours: bianco



Special colours
on request

Weight:
Falena 2
net kg 3,00

Falena 3
net kg 5,20

Fluo light bulbs
not included
→ specifications p. 170

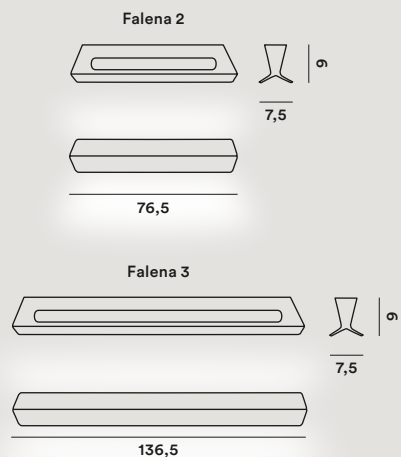

collection →



p. 138

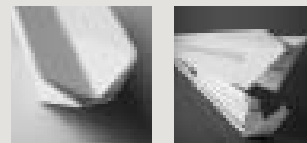

Folio

Carlo Urbinati e Alessandro Vecchiato, 1990



Blown acid-etched glass and coated metal

Halo 1x120W R7s

⊕ ⚡ CE IP 20

	energy cl.	colours	code	vat excluded
<i>Folio grande halogen</i>	C	bianco	019008 10	359,00
Spare parts:				
<i>Glass Folio grande</i>		bianco	019S001 10	211,00
<i>Halogen protection glass</i>			PIREX94/4/I	18,00

Colours: bianco



Special colours
on request

Weight:
net kg 2,20

Halo light bulbs
not included
→ specifications p. 170

collection →



48



p. 141



Gregg

Ludovica e Roberto
Palomba, 2007



	energy cl.	colours	code	vat excluded
<i>Gregg media</i>	A ⁺ , A, B, C	bianco	168005 10	298,00
<i>Gregg piccola</i>	C	bianco	1680052 10	145,00
Spare parts:				
<i>Glass Gregg media</i>		bianco	168S00 10	172,00
<i>Glass Gregg piccola</i>		bianco	168S00210	59,00

Blown acid-etched and white lacquered metal

Gregg media
LED retrofit / Fluo
1x25W E27
Halo 1x150W E27

Gregg piccola
Halo 1x20W G9



Colours: bianco



Special colours
on request

Weight:
Gregg media
net kg 2,90

Gregg piccola
lor kg 0,90

Halo, Fluo, LED retrofit
light bulbs not included
→ specifications p. 170

media

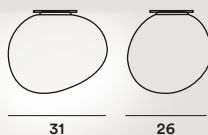

31

26

27

piccola



13

11

collection →

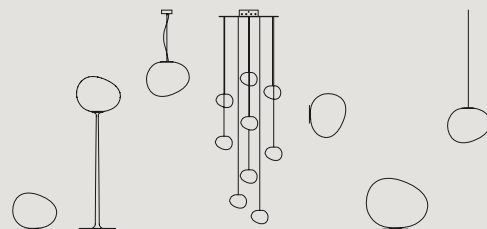

p. 022 p. 043 p. 073 p. 102 p. 142 p. 156 p. 159



Lumiere xxl + xxs

Rodolfo Dordoni, 2010



Blown glass and lacquered metal

Lumiere xxl
Fluo 1x40W + 1x22W 2GX13
Fluo 1x55W dimmable
2GX13

Lumiere xxs
Fluo 2x18W G24q-2

Dimmable version
Possible configurations:
On-Off/Push/DALI



	energy cl.	colours	code	vat excluded
<i>Lumiere xxl</i>	A ⁺ , A	bianco	191005 11	361,00
<i>Lumiere xxs</i>	A ⁺ , A	bianco	1910052 11	308,00
<i>Lumiere xxl dimmable</i>	A ⁺ , A	bianco	191005DM 11	434,00
Spare parts:				
<i>Glass Lumiere xxl</i>		bianco	191S0051 11	203,00
<i>Glass Lumiere xxs</i>		bianco	191S0052 11	146,00

Colours: bianco



Special colours
on request

Weight:
Lumiere xxl
net kg 3,40

Lumiere xxs
net kg 1,80

Fluo light bulbs
not included
→ specifications p. 170

Lumiere xxl

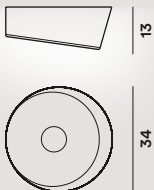

Lumiere xxs

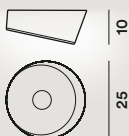

collection →

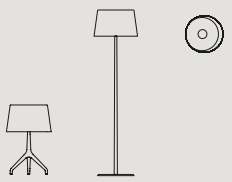

p. 027

p. 046

p. 148



Nuage

Philippe Nigro, 2012

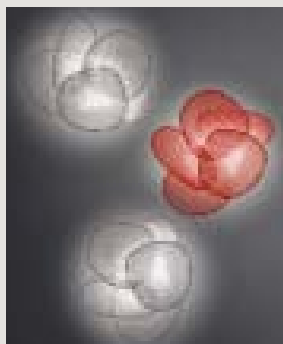

Injection-moulded polycarbonate and batch-dyed ABS

Fluo 1x40W + 1x22W 2GX13 dimmable 1x55W 2GX13

Dimmable version
Possible configurations:
On-Off/Push/DALI

Usable in composition



	energy cl.	colours	code	vat excluded
Nuage	A ⁺ , A	bianco	243005 10	407,00
		verde	243005 40	
		rosso	243005 63	
Nuage dimmable	A ⁺ , A	bianco	243005DM 10	460,00
		verde	243005DM 40	
		rosso	243005DM 63	
Accessories				
Lamp connection kit		40+22W	243KIT	24,00
		dimmable	243KIT DM	36,00
Spare parts:				
Set lampshades Nuage		bianco	243S00 10	281,00
		verde	243S00 40	
		rosso	243S00 63	

Colours: bianco, verde, rosso

Weight: net kg 3,20

Fluo light bulbs not included
→ specifications p. 170

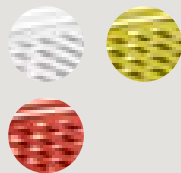

Special colours on request

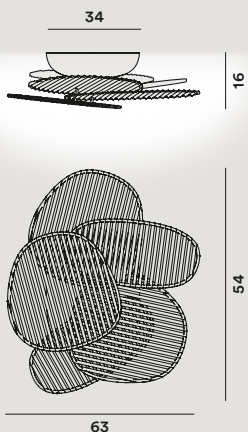

collection →

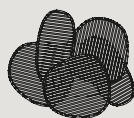

p. 149



Rituals

Ludovica e Roberto
Palomba, 2015



	energy cl.	colours	code	vat excluded
<i>Rituals 1</i>	A ⁺ , A, B, C	bianco	2440081 10	345,00
<i>Rituals 2</i>	A ⁺ , A, B, C	bianco	2440082 10	345,00
<i>Rituals 3</i>	A ⁺ , A, B, C	bianco	2440083 10	290,00
Spare parts:				
<i>Glass Rituals 1</i>		bianco	244S001 10	222,00
<i>Glass Rituals 2</i>		bianco	244S002 10	222,00
<i>Glass Rituals 3</i>		bianco	244S003 10	167,00

Blown satin glass and
lacquered metal

LED retrofit / Fluo
1x20W E27
Halo 1x70W E27



Colours: bianco



Weight:
Rituals 1
net kg 4,00

Rituals 2
net kg 2,10

Rituals 3
net kg 1,60

Halo, Fluo, LED retrofit
light bulbs not included
→ specifications p. 170

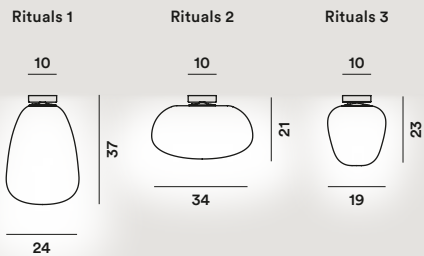

collection →

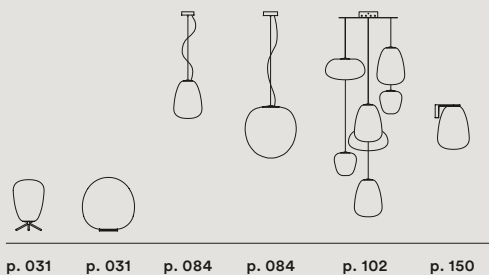

Tivu

Joseph Forakis, 2011

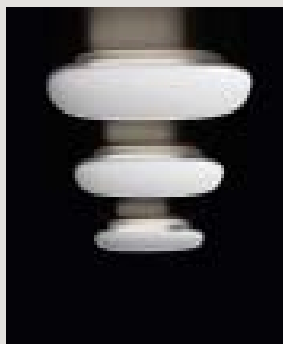

	energy cl.	colours	code	vat excluded
<i>Tivu grande</i>	A ⁺ , A	bianco	207005 10	202,00
		nero	207005 20	

Injection-moulded polycarbonate

Fluo 2x18W 2G11



Colours: bianco, nero



Special colours on request

Weight: net kg 1,30

Fluo light bulbs not included
→ specifications p. 170

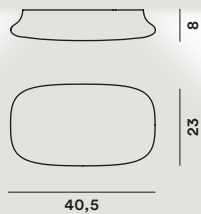

collection →

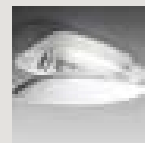

Twiggy

Marc Sadler, 2007



	energy cl.	colours	code	vat excluded
<i>Twiggy</i>	A ⁺ , A, B, C	bianco	159008 10	950,00
		nero	159008 20	

Spare parts:

<i>Lampshade Twiggy</i>	bianco	159S10 10	464,00
	nero	159S10 20	
<i>Lower diffusor disk</i>		159R05	29,00

Compound material on lacquered glass fibre base, PMMA and lacquered metal

LED retrofit / Fluo
3x20W E27
Halo 3x77W E27

Rotating 330°

Stem lenght cannot be changed



Colours:
bianco, nero



Special colours
on request

Weight:
net kg 5,60

Halo, Fluo, LED retrofit
light bulbs not included
→ specifications p. 170

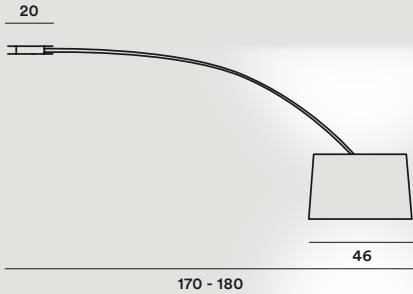

collection →

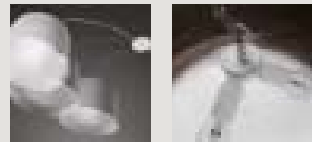
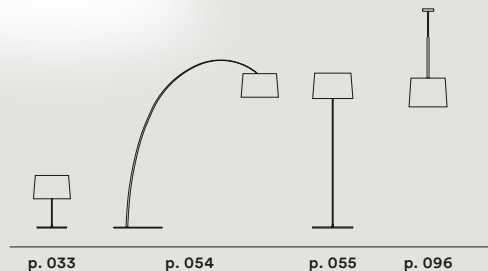
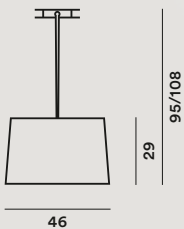



Parete, Wall

- | | | | |
|-----|-------------------------------|-----|------------------------------|
| 128 | Aplomb | 141 | Folio |
| 129 | Bahia +
Bahia mini | 142 | Gregg |
| 130 | Big Bang | 143 | Havana |
| 131 | Birdie | 144 | Innerlight |
| 132 | Bit | 145 | Kite |
| 133 | Blob S | 146 | Lake |
| 134 | Caboche | 147 | Le Soleil |
| 135 | Circus | 148 | Lumiere
xxl + xxs |
| 136 | Double | 149 | Nuage |
| 137 | Ellepi | 150 | Rituals |
| 138 | Falena | 151 | Tivu |
| 139 | Fields | 152 | Tress |
| 140 | Flip | 153 | Tutù |

Aplomb

Lucidi e Pevere, 2014



	energy cl.	colours	code	vat excluded
Aplomb	A ⁺	bianco	195005L 10	410,00
		grigio	195005L 25	
		marrone	195005L 52	

Concrete, varnished metal and aluminium

LED included
13W 2700°K 1120 lm
CRI > 80 86 lm/W

Dimmable only with Seoul-Acrich LED compatible modules



Colours: bianco, grigio cemento, marrone

Weight: net kg 2,00



Tecnico — 2016

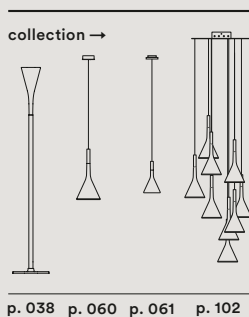
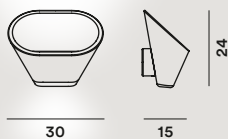

Bahia + Bahia mini

Lucidi e Pevere, 2010-2015

LED



	energy cl.	colours	code	vat excluded
<i>Bahia fluo</i>	A ⁺ , A	bianco	196005 10	445,00
<i>Bahia LED</i>	A ⁺	bianco	196005L 10	608,00
<i>Bahia LED dimmable</i>	A ⁺	bianco	196005LD 10	671,00
<i>Bahia mini fluo</i>	A ⁺ , A	bianco	1960052 10	248,00
<i>Bahia mini fluo dimmable</i>	A ⁺ , A	bianco	1960052D 10	294,00
<i>Bahia mini LED</i>	A ⁺	bianco	1960052L 10	399,00
<i>Bahia mini LED dimmable</i>	A ⁺	bianco	1960052LD 10	450,00

Injection moulded
polycarbonate

Bahia
LED included
43W 2850° K 4850 lm
CRI>90 113 lm/W
Dimmable LED version
Possible configurations:
On-Off/Push/DALI

Fluo 1x40W + 1x22W 2GX13

Bahia mini
LED included 21W 2850° K
2425 lm CRI>90 115 lm/W
Dimmable LED version
Possible configurations:
On-Off/Push/DALI

Fluo 1x22W 2GX13

Dimmable Fluo version
Possible configurations:
On-Off/Push/DALI



Colours: bianco



Weight:
Bahia
net kg 3,40

Bahia mini
net kg 2,00

Fluo light bulbs
not included
→ specifications p. 170

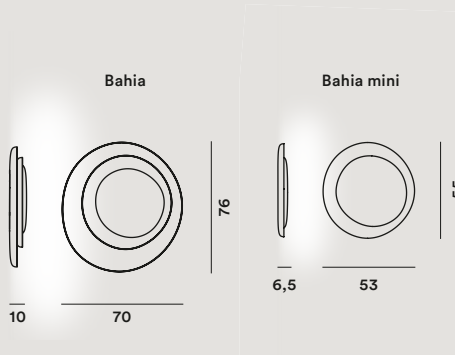

collection →



p. 110

p. 110

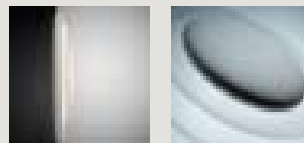

Big Bang

Enrico Franzolini con Vicente Garcia Jimenez, 2005



Methacrylate and lacquered metal

Halo 1x120W R7s

⊕ ⚡ CE IP 20

	energy cl.	colours	code	vat excluded
<i>Big Bang</i>	C	bianco	151005 10	429,00
		rosso	151005 63	445,00

Spare parts:

<i>Set lampshades Big Bang</i>		bianco	151S05 10	254,00
		rosso	151S05 63	270,00
<i>Halogen protection glass</i>			PIREX94/4/I	18,00

Colours:
bianco, rosso

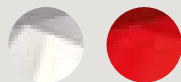

Special colours
on request

Weight:
net kg 3,00

Halo light bulbs
not included
→ specifications p. 170

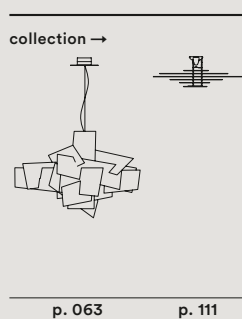
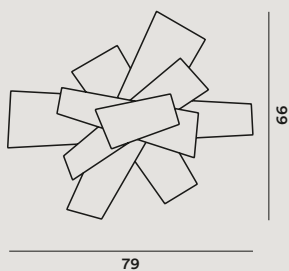

Birdie

Ludovica e Roberto
Palomba, 2012



Polycarbonate, coated steel
and metal

Birdie
LED retrofit / Fluo
1x25W E27
Halo 1x70W E27

⊕ ⊖ CE IP 20

Birdie with touch dimmer
Halo 1x70W E27
(minimum bulb output 40W)*

⊕ ⊖ CE IP 20

	energy cl.	colours	code	vat excluded
Birdie	A ⁺ , A, B, C	bianco	2210052 10	215,00
		grigio	2210052 25	
		arancio	2210052 53	
		amaranto	2210052 65	
Birdie with touch dimmer	A ⁺ , A, B, C	bianco	2210052DM 10	267,00
		grigio	2210052DM 25	
		arancio	2210052DM 53	
		amaranto	2210052DM 65	
Spare parts:				
Lampshade Birdie		bianco	221S002 10	46,00
		grigio	221S002 25	
		arancio	221S002 53	
		amaranto	221S002 65	

Colours: bianco, grigio,
arancio, amaranto

Weight:
net kg 1,60

Halo, Fluo, LED retrofit
light bulbs not included
→ specifications p. 170



Special colours
on request

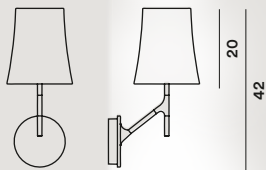

17

24

collection →

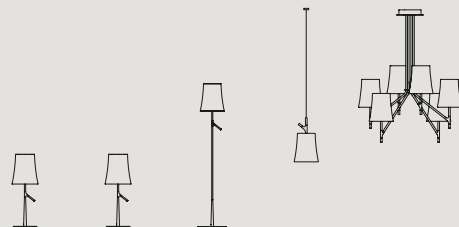

p.016

p.017

p. 039

p. 064

p. 112

Bit

Ferruccio Laviani, 1993



Silkscreen-printed glass and lacquered metal

LED retrofit / Fluo
1x12W E14
Halo 1x46W E14



	energy cl.	colours	code	vat excluded
Bit 1	A ⁺ , A, B, C	rosso	0430051	196,00
		bianco	0430051 10	
Bit 2	A ⁺ , A, B, C	blu	0430052	196,00
		bianco	0430052 10	
Bit 3	A ⁺ , A, B, C	bianco	0430053	196,00
Bit 4	A ⁺ , A, B, C	verde	0430054	196,00
		bianco	0430054 10	
Bit 5	A ⁺ , A, B, C	arancio	0430055	196,00
		bianco	0430055 10	

Spare parts:

Glass Bit 1	bianco	043S00/1 10	50,00
	rosso	043S00/1 63	
Glass Bit 2	bianco	043S00/2 10	50,00
	blu	043S00/2 33	
Glass Bit 3	bianco	043S00/3 10	50,00
Glass Bit 4	bianco	043S00/4 10	50,00
	verde	043S00/4 40	
Glass Bit 5	bianco	043S00/5 10	50,00
	arancio	043S00/5 52	

Colours: bianco, colorato
(1 rosso, 2 blu, 4 verde,
5 arancio)

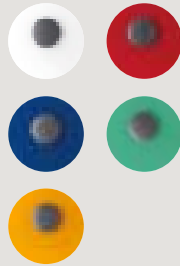

Weight:

Bit 1
net kg 1,70
Bit 2
net kg 1,20
Bit 3
net kg 1,80
Bit 4
net kg 1,25
Bit 5
net kg 1,35

Halo, Fluo, LED retrofit
light bulbs not included
→ specifications p. 170

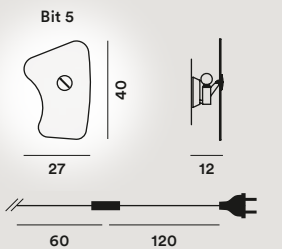
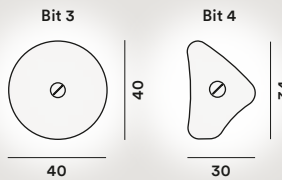
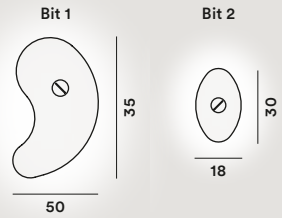

Special colours
on request

collection →



p. 049

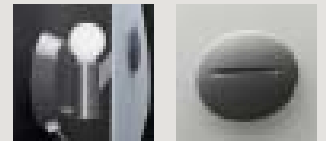

Blob S

Karim Rashid, 2002



	energy cl.	colours	code	vat excluded
<i>Blob S</i>	A ⁺ , A	bianco	124035 10	185,00
Spare parts:				
<i>Lampshade Blob S</i>	A ⁺ , A	bianco	124S00 10	62,00

Rotational moulded
polyethylene

Fluo 1x24W 2G11

☐ ▽ CE IP 20

Colours: bianco



Weight:
net kg 1,10

Fluo light bulbs
not included
→ specifications p. 170

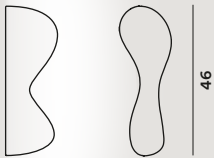

16

16

46

collection →



p. 114



Caboche

Patricia Urquiola
con Eliana Gerotto, 2006



PMMA, blown glass and
chromed metal

Halo 1x120W R7s



	energy cl.	colours	code	vat excluded
<i>Caboche media</i>	C	trasparente	138005 16	576,00
		giallo oro	138005 52	
<i>Caboche piccola</i>	C	trasparente	138025 16	303,00
		giallo oro	138025 52	
Spare parts:				
<i>Set sphere Caboche media</i>		trasparente	138S05 16	235,00
		giallo oro	138S05 52	
<i>Kit 15 prongs 3 sphere Caboche media</i>			138KIT 15M3	26,00
<i>Kit 15 prongs 4 sphere Caboche media</i>			138KIT 15M4	26,00
<i>Kit 3+3 prongs, 3-4 sphere Caboche media</i>			138KIT-R2	19,00
<i>Set sphere Caboche piccola</i>		trasparente	138S005 16	95,00
		giallo oro	138S005 52	
<i>Kit 10 prongs, 3 sphere Caboche piccola</i>			138KIT 10P3	23,00
<i>Kit 10 prongs 4 sphere Caboche piccola</i>			138KIT 10P4	23,00
<i>Kit 3+3 prongs 3-4 sphere Caboche piccola</i>			138KIT2-R2	18,00
<i>Glass Caboche</i>			138V052/1	58,00
<i>Halogen protection glass</i>			PIREX94/4/1	18,00

Colours:
trasparente, giallo oro

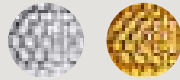

Special colours
on request

Weight:
Caboche media
net kg 4,50

Caboche piccola
net kg 2,60

Halo light bulbs
not included
→ specifications p. 170

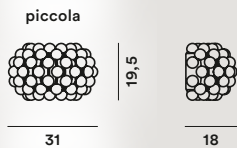
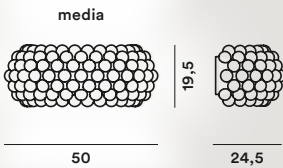

collection →

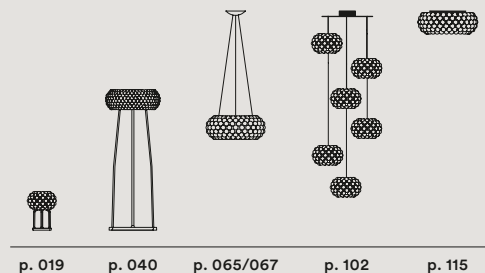

Circus

Defne Koz, 1994

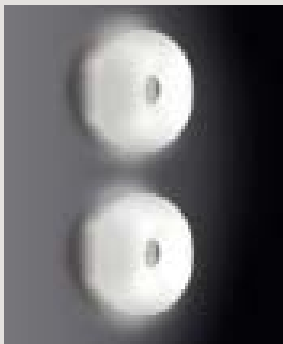

	energy cl.	colours	code	vat excluded
<i>Circus grande</i>	A ⁺ , A, B, C	bianco	0460081 11	420,00
<i>Circus piccola</i>	A ⁺ , A, B, C	bianco	046008 11	267,00

Spare parts:

<i>Glass Circus grande</i>	bianco	046S001 11	270,00
<i>Glass Circus piccola</i>	bianco	046S00 11	150,00

Blown glass, nickel-plated or coated metal

Circus grande
LED retrofit / Fluo
4x12W E27
Halo 4x46W E27

Circus piccola
LED retrofit / Fluo
4x8W E14
Halo 4x30W E14



IP 20

Colours: bianco



Special colours
on request

Weight:
Circus grande
net kg 4,70

Circus piccola
net kg 2,10

Halo, Fluo, LED retrofit
light bulbs not included
→ specifications p. 170

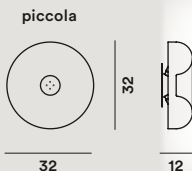
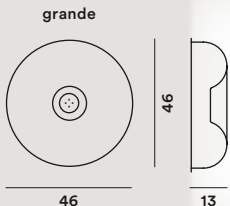

collection →



p. 116

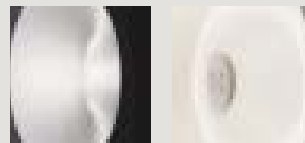

Double

Valerio Bottin, 1996



	energy cl.	colours	code	vat excluded
<i>Double</i>	A ⁺ , A, B, C	bianco	069005 11	269,00
		avorio	069005 51	
Spare parts:				
<i>Glass Double</i>		bianco	069S00 11	158,00
		avorio	069S00 51	

Blown glass and coated metal

LED retrofit / Fluo
2x20W E27
Halo 2x77W E27



Colours:
bianco, avorio



Special colours
on request

Weight:
netto kg 2,00

Halo, Fluo, LED retrofit
light bulbs not included
→ specifications p. 170

Tecnico — 2016



26

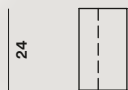

13



Ellepi

Alessandra Matilde, 2003



Methacrylate and coated
metal

Fluo 1x55W 2GX13

⊕ ⚡ CE IP 20

	energy cl.	colours	code	vat excluded
<i>Ellepi</i>	A ⁺ , A	bianco	128005 10	399,00
Spare parts:				
<i>Lampshade Ellepi</i>		bianco	128S00 10	206,00

Weight: bianco



Special colours
on request

Peso:
netto kg 4,30

Fluo light bulbs
not included
→ specifications p. 170

collection →

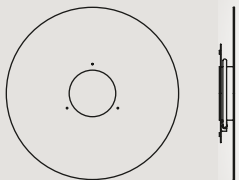

74

6,5

p. 117

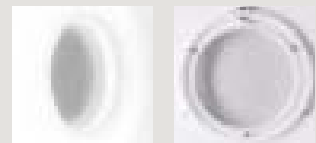

Falena

Lucidi e Pevere, 2011

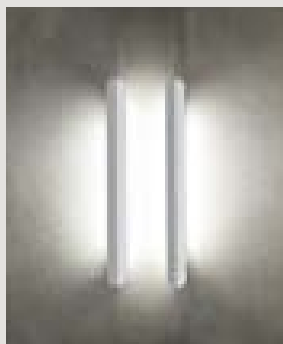

	energy cl.	colours	code	vat excluded
<i>Falena 1</i>	C	bianco	215005 10	206,00
<i>Falena 2</i>	A ⁺ , A	bianco	215005F2 10	391,00
<i>Falena 3</i>	A ⁺ , A	bianco	215005F3 10	515,00
<i>Falena 2 dimmable</i>	A ⁺ , A	bianco	215005F2DM 10	476,00
<i>Falena 3 dimmable</i>	A ⁺ , A	bianco	215005F3DM 10	601,00
Spare parts:				
<i>Halogen protection glass</i>			PIREX94/4/I	18,00

Coated aluminium and polycarbonate

Falena 1
Halo 1x80W R7s

Falena 2
Fluo 1x24W G5

Falena 3
Fluo 1x54W G5

Falena 2-3
Horizontal and vertical use

Dimmable version possible
configurations:
On-Off/Push/DALI



Colours:
bianco



Special colours
on request

Weight:
Falena 1
net kg 0,80

Falena 2
net kg 3,00

Falena 3
net kg 5,20

Halo, Fluo light bulbs
not included
→ specifications p. 170

Falena 1



22

9

Falena 2

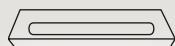

76,5

9

Falena 3

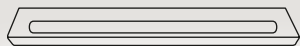

136,5

9

7,5

collection →



Fields

Vicente Garcia Jimenez,
2007

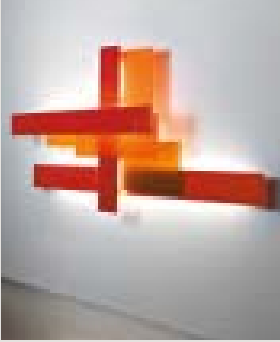

Methacrylate, coated
aluminium and
polycarbonate

Fields 1
Fluo 1x80W G5

Fields 2
Fluo 1x54W G5

Fields 3
Fluo 1x39W G5

Horizontal and vertical use

Fields
Fluo 1x80W G5 + 1x54W G5
+ 1x39W G5



	energy cl.	colours	code	vat excluded
<i>Fields</i>	A ⁺ , A	bianco	174005 10	1.771,00
		arancio	174005 63	
<i>Fields 1</i>	A ⁺ , A	bianco	1740051 10	550,00
		arancio	1740051 63	
<i>Fields 2</i>	A ⁺ , A	bianco	1740052 10	645,00
		arancio	1740052 63	
<i>Fields 3</i>	A ⁺ , A	bianco	1740053 10	576,00
		arancio	1740053 63	
Spare parts:				
<i>Set lampshades Fields 2</i>		bianco	174S002 10	87,00
		arancio	174S002 63	
<i>Set lampshades Fields 3</i>		bianco	174S003 10	85,00
		arancio	174S003 63	

Colours:
bianco, arancio

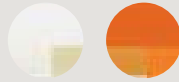

Special colours
on request

Weight:
Fields 1
net kg 6,00

Fields 2
net kg 6,50

Fields 3
net kg 5,80

Fields
net kg 18,30

Fluo light bulbs
not included
→ specifications p. 170

Fields 1



Fields 2

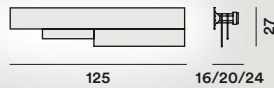

Fields 3

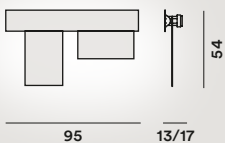

Fields

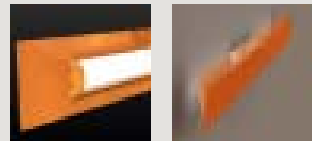
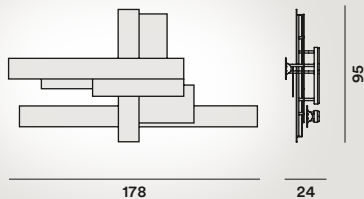

Flip

Simon Pengelly, 2013



	energy cl.	colours	code	vat excluded
<i>Flip halogen</i>	C	bianco	251005 10	242,00
<i>Flip LED</i>	A	bianco	251005L 10	382,00
Spare parts:				
<i>Lampshade Flip</i>			251S00 10	81,00
<i>Halogen protection glass</i>			PIREX94/4/1	18,00

Injection moulded coated polycarbonate and coated metal or aluminium (LED)

Flip halogen
1x120W R7s

Flip LED
LED included
16W 2700°K
1200 lm CRI > 80 75 lm/W

Dimmable only with Seoul-Acrich LED compatible modules



Colours: bianco



Special colours on request

Weight:
net kg 1,20

Halo light bulbs not included
→ specifications p. 170

Tecnico — 2016

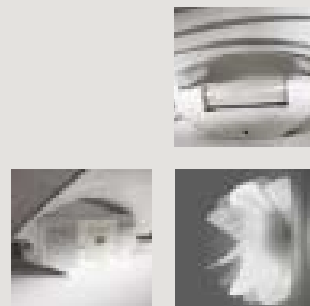
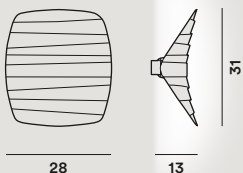

Folio

Carlo Urbinati e Alessandro Vecchiato, 1990



Blown acid-etched glass and coated metal

Halo 1x120W R7s

⊕ ⚡ CE IP 20

	energy cl.	colours	code	vat excluded
<i>Folio grande halogen</i>	C	bianco	0190051 10	336,00
<i>Folio piccola halogen</i>	C	bianco	019005-R1 10	252,00

Spare parts:

<i>Glass Folio grande</i>	bianco	019S001 10	211,00
<i>Glass Folio piccola</i>	bianco	019S00 10	131,00
<i>Halogen protection glass</i>	bianco	PIREX94/4/I	18,00

Colours: bianco



Special colours on request

Weight:

Folio grande
net kg 2,17

Folio piccola
net kg 1,48

Halo light bulbs

not included

→ specifications p. 170

grande

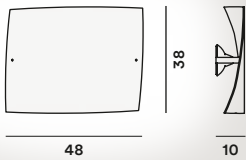

collection →



piccola

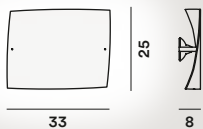

p. 119



Gregg

Ludovica e Roberto
Palomba, 2007

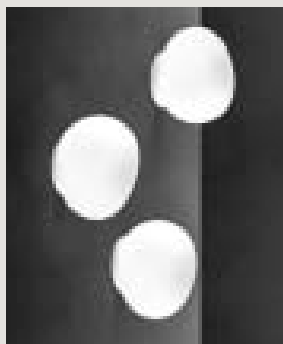

	energy cl.	colours	code	vat excluded
<i>Gregg media</i>	A ⁺ , A, B, C	bianco	168005 10	298,00
<i>Gregg piccola</i>	C	bianco	1680052 10	145,00

Spare parts:

<i>Glass Gregg media</i>	bianco	168S00 10	172,00
<i>Glass Gregg piccola</i>	bianco	168S00210	59,00

Blown acid-etched glass and coated metal

Gregg media
LED retrofit / Fluo
1x25W E27
Halo 1x150W E27

Gregg piccola
Halo 1x20W G9



Colours: bianco



Special colours
on request

Weight:
Gregg media
net kg 2,90

Gregg piccola
net kg 0,60

Halo, Fluo, LED retrofit
light bulbs not included
→ specifications p. 170

media

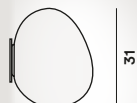

27

piccola



12

collection →

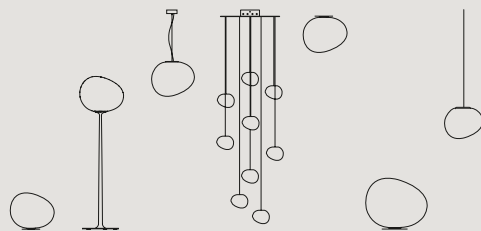

p. 022 p. 043 p. 073 p. 102 p. 120 p. 156 p. 159

Havana

Joseph Forakis, 1993



	energy cl.	colours	code	vat excluded
<i>Havana</i>	A+, A, B, C	bianco	0400072-R1 10	200,00
Spare parts:				
<i>Set lampshades Havana</i>		bianco	040S00 10	79,00

Injection moulded polyethylene and coated metal

LED retrofit / Fluo
1x25W E27
Halo 1x116W E27



Colours: bianco



Special colours on request

Weight:
net kg 1,90

Halo, Fluo, LED retrofit light bulbs not included
→ specifications p. 170

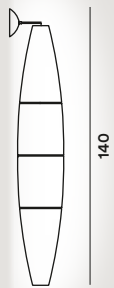

27

collection →

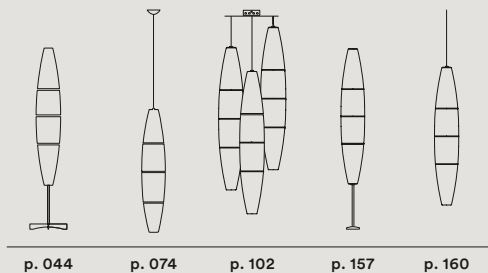

Innerlight

Simon Pengelly, 2012

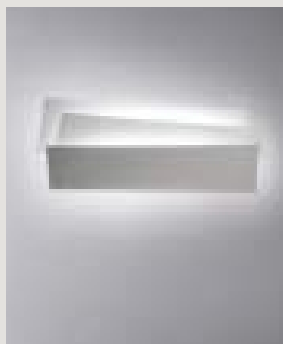

	energy cl.	colours	code	vat excluded
<i>Innerlight</i>	A ⁺ , A	bianco	233005 10	412,00
		marrone	233005 52	531,00
<i>Innerlight dimmable</i>	A ⁺ , A	bianco	233005DM 10	476,00
		marrone	233005DM 52	595,00

Translucent polycarbonate and coated or acid-etched steel

Fluo 2x36W 2G11

Dimmable version possible configurations:
On-Off/Push/DALI



Colours:
bianco, marrone



Special colours
on request

Weight:
net kg 5,00

Fluo light bulbs
not included
→ specifications p. 170



77



11



Kite

Marc Sadler, 2003



Fiberglass fabric with carbonium thread

LED retrofit / Fluo
3x12W E14
Halo 3x30W E14



	energy cl.	colours	code	vat excluded
<i>Kite</i>	A ⁺ , A, B, C	nero	1110051 20	269,00
Spare parts:				
<i>Lampshade Kite</i>		nero	111S005 20	199,00

Colours: nero



Weight:
net kg 0,50

Halo, Fluo, LED retrofit
light bulbs not included
→ specifications p. 170

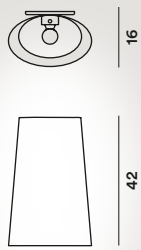

27

collection →

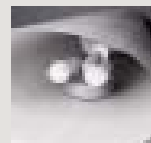
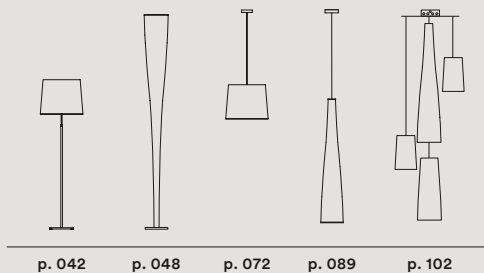

Lake

Lucidi e Pevere, 2015



	energy cl.	colours	code	vat excluded
Lake	A	avorio	257005 50	387,00
		rosso	257005 63	

Injection moulded ABS.

LED included
12,7W 3000° K 850 lm
CRI>80 67 lm/W

Dimmable only with Seoul-
Acrich LED compatible
modules

☐ ▽ CE ◀ IP 20

Colours:
avorio, rosso



Weight:
net kg 5,50

Tecnico — 2016

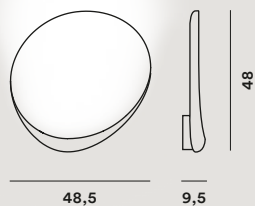

Le Soleil

Vicente Garcia Jimenez,
2013



	energy cl.	colours	code	vat excluded
<i>Le soleil</i>	A ⁺ , A	bianco	181005 10	279,00
		acquamarina	181005 34	
		rosso	181005 63	
<i>Le soleil dimmable</i>	A ⁺ , A	bianco	181005DM 10	336,00
		acquamarina	181005DM 34	
		rosso	181005DM 63	
Spare parts:				
<i>Set lampshades Le soleil</i>		bianco	181S005 10	112,00
		acquamarina	181S005 34	
		rosso	181S005 63	

Injection moulded varnished polycarbonate and coated metal

Fluo 2x26W G24-q3

Dimmable version possible configurations:
On-Off/Push/DALI

⊕ ⚡ CE IP 20

Colours: bianco, acquamarina, rosso

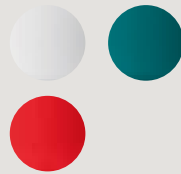

Special colours on request

Weight:
net kg 1,60

Fluo light bulbs not included
→ specifications p. 170

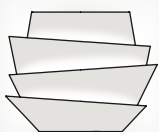

37

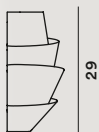

14

collection →



p. 076



Lumiere xxl + xxs

Rodolfo Dordoni, 2010



	energy cl.	colours	code	vat excluded
<i>Lumiere xxl</i>	A ⁺ , A	bianco	191005 11	361,00
<i>Lumiere xxs</i>	A ⁺ , A	bianco	1910052 11	308,00
<i>Lumiere xxl dimmable</i>	A ⁺ , A	bianco	191005DM 11	434,00
Spare parts:				
<i>Glass Lumiere xxl</i>		bianco	191S0051 11	203,00
<i>Glass Lumier xxs</i>		bianco	191S0052 11	146,00

Blown glass and lacquered metal

Lumiere xxl
Fluo 1x40W + 1x22W 2GX13
Dimmable 1x55W 2GX13

Dimmable version possible configurations:
On-Off/Push/DALI

Lumiere xxs
Fluo 2x18W G24q-2



Colours: bianco



Special colours on request

Weight:
Lumiere xxl
net kg 3,40

Lumiere xxs
net kg 1,80

Fluo light bulbs not included
→ specifications p. 170

Lumiere xxl

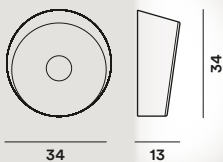

Lumiere xxs

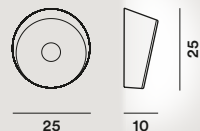

collection →

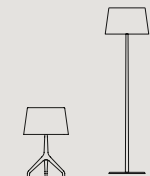

p. 027 p. 046 p. 121

Nuage

Philippe Nigro, 2012

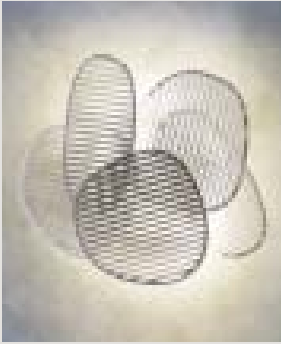

Injection-moulded polycarbonate and batch-dyed ABS

Fluo 1x40W + 1x22W 2GX13
Dimmable 1x55W 2GX13

Dimmable version
Possible configurations:
On-Off/Push/DALI

Usable in composition



	energy cl.	colours	code	vat excluded
Nuage	A ⁺ , A	bianco	243005 10	407,00
		verde	243005 40	
		rosso	243005 63	
Nuage dimmable	A ⁺ , A	bianco	243005DM 10	460,00
		verde	243005DM 40	
		rosso	243005DM 63	
Accessories				
Lamp connection set		40+22W	243KIT	24,00
		dimmable	243KIT DM	36,00
Spare parts:				
Set lampshades Nuage		bianco	243S00 10	281,00
		verde	243S00 40	
		rosso	243S00 63	

Colours: bianco, verde, rosso

Weight:
net kg 3,20

Fluo light bulbs
not included
→ specifications p. 170

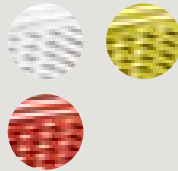

Special colours
on request

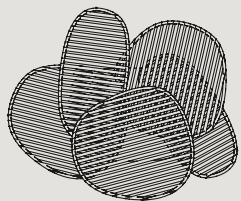

63

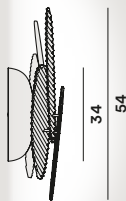

16

collection →



p. 122

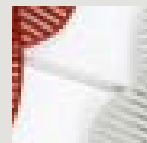

Rituals

Ludovica e Roberto
Palomba, 2015



	energy cl.	colours	code	vat excluded
<i>Rituals 1</i>	A ⁺ , A, B, C	bianco	2440051 10	375,00
<i>Rituals 3</i>	A ⁺ , A, B, C	bianco	2440053 10	327,00
<i>Rituals 1 doppia on request</i>	A ⁺ , A, B, C	bianco	24400512 10	693,00
<i>Rituals 3 doppia on request</i>	A ⁺ , A, B, C	bianco	24400532 10	601,00
Spare parts:				
<i>Glass Rituals 1</i>		bianco	244S001 10	222,00
<i>Glass Rituals 3</i>		bianco	244S003 10	167,00

Blown satin glass and
lacquered metal

Rituals 1-3
LED retrofit / Fluo
1x15W E27
Halo 1x70W E27

Rituals 1-3 doppia
LED retrofit / Fluo
2x15W E27
Halo 2x70W E27



Colours: bianco



Weight:
Rituals 1
net kg 4,80

Rituals 3
net kg 2,40

Rituals 1 doppia
net kg 8,80

Rituals 3 doppia
net kg 6,00

Halo, Fluo, LED retrofit
light bulbs not included
→ specifications p. 170

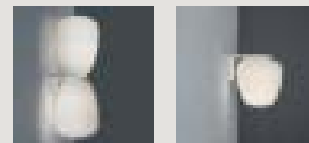
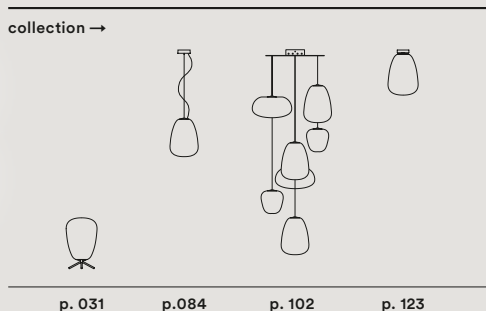
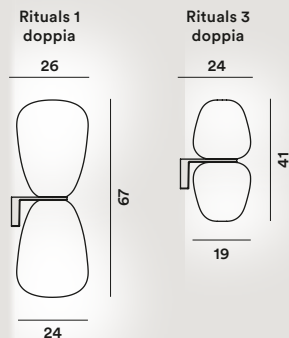
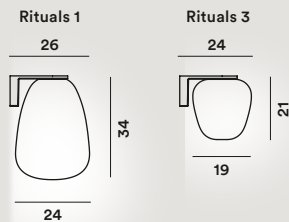

Tivu

Joseph Forakis, 2011

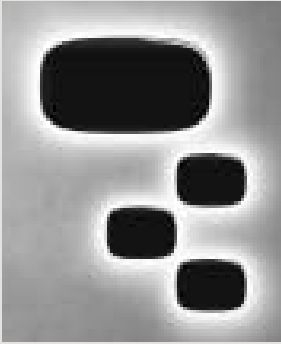

	energy cl.	colours	code	vat excluded
<i>Tivu grande</i>	A ⁺ , A	bianco	207005 10	202,00
		nero	207005 20	
<i>Tivu piccola</i>	C	bianco	2070052 10	112,00
		nero	2070052 20	

Injection moulded polycarbonate

Tivu grande
Fluo 2x18W 2G11
Horizontal and vertical use



Tivu piccola
Halo 1x20W G9

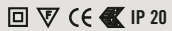

Colours:
bianco, nero



Weight:
Tivu grande
net kg 1,30

Tivu piccola
net kg 0,30

Halo, Fluo light bulbs
not included
→ specifications p. 170

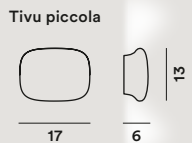
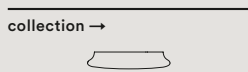
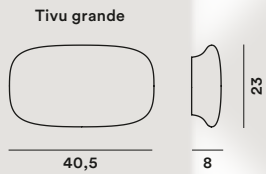

Tress

Marc Sadler, 2011

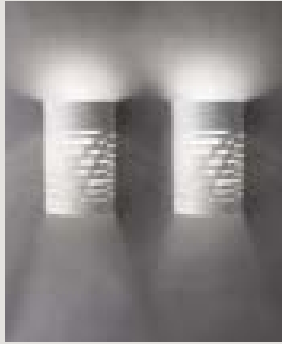

Coated fibreglass-based composite material and coated metal

Halo 1x120W R7s



	energy cl.	colours	code	vat excluded
<i>Tress grande</i>	C	bianco	182005 10	395,00
		nero	182005 63	
<i>Tress piccola</i>	C	bianco	1820052 10	349,00
		nero	1820052 63	
Spare parts:				
<i>Lampshade Tress grande</i>		bianco	182S005 10	255,00
		nero	182S005 63	
<i>Lampshade Tress piccola</i>		bianco	182S0052 10	209,00
		nero	182S0052 63	
<i>Halogen protection glass</i>			PIREX94/4/1	18,00

Colours: bianco, nero, rosso



Special colours on request

Weight:
Tress grande
net kg 1,10

Tress piccola
net kg 1,00

Halo light bulbs not included
→ specifications p. 170

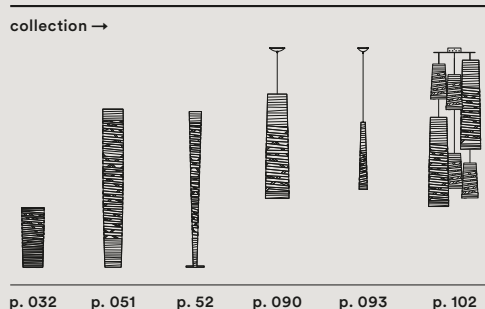
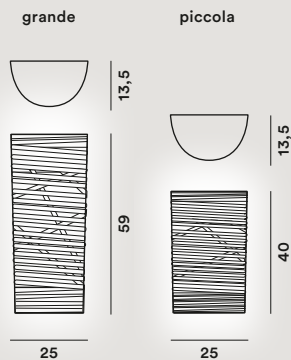

Tutù

Valerio Bottin, 2001



	energy cl.	colours	code	vat excluded
<i>Tutù</i>	A ⁺ , A, B, C	bianco	114005I 11	185,00
		avorio	114005I 51	

Spare parts:

<i>Glass Tutù</i>	bianco	114S005 11	87,00
	avorio	114S005 51	

Blown glass, metal and aluminium

LED retrofit / Fluo
2x12W E14
Halo 2x46W E14



IP 20

Colours:
bianco, avorio



Special colours
on request

Weight:
net kg 0,80

Halo, Fluo, LED retrofit
light bulbs not included
→ specifications p. 170

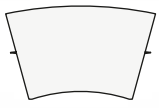

29



18

13





Esterno, *Outdoor*156 **Gregg***outdoor terra*157 **Havana***outdoor terra*158 **Solar** *outdoor*159 **Gregg***outdoor sospensione*160 **Havana***outdoor sospensione*161 **Uto**

Gregg outdoor

terra

Ludovica e Roberto Palomba,
2011



	energy cl.	colours	code	vat excluded
<i>Gregg outdoor X-large</i>	A ⁺ , A	bianco	218003 10	328,00
<i>Gregg outdoor grande</i>	A ⁺ , A	bianco	218013 10	250,00
<i>Gregg outdoor media</i>	A ⁺ , A	bianco	218023 10	192,00

Spare parts:				
<i>Lampshade Gregg outdoor X-large</i>		bianco	218S001 10	179,00
<i>Lampshade Gregg outdoor grande</i>		bianco	218S00 10	101,00
<i>Lampshade Gregg outdoor media</i>		bianco	218S002 10	63,00

Rotational moulded polyethylene and coated metal

X-large / grande
LED retrofit / Fluo
1x25W E27

media
LED retrofit / Fluo
1x15W E27

IP 65 - IP 44

Colours: bianco



Weight:
X-large
net kg 4,30

grande
net kg 3,60

media
net kg 1,60

Fluo, LED retrofit light bulbs not included
→ specifications p. 170

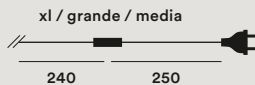
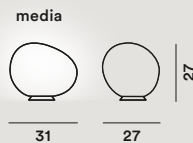
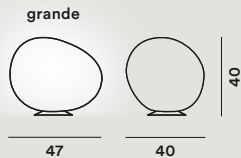
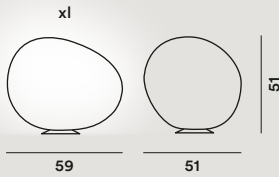

collection →

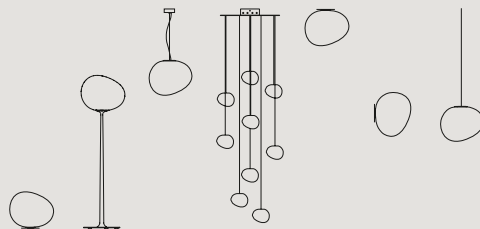

p. 022 p. 043 p. 073 p. 102 p. 120 p. 142 p. 159

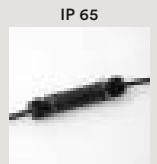

Havana outdoor

terra
Jozeph Forakis, 2005



Rotational moulded polyethylene and coated metal

LED retrofit / Fluo
1x15W E27
Halo 1x46W E27

IP 65 - IP 44

	energy cl.	colours	code	vat excluded
<i>Havana out. terra undergr. base</i>	A+, A, B, C	bianco	150003 10	592,00
<i>Havana out. terra stake mounted</i>	A+, A, B, C	bianco	1500031 10	500,00
<i>Havana out. terra base</i>	A+, A, B, C	bianco	1500032 10	569,00
<i>Havana out. terra bassa undergr. base</i>	A+, A, B, C	bianco	150004 10	583,00
<i>Havana out. terra bassa stake mounted</i>	A+, A, B, C	bianco	1500041 10	491,00
<i>Havana out. terra bassa base</i>	A+, A, B, C	bianco	1500042 10	560,00

Spare parts:

<i>Lampshade Havana outdoor</i>	bianco	150S00 10	148,00
<i>Underground base</i>		150S032	107,00
<i>Stake mounted</i>		150S031	91,00
<i>Base</i>		150S033-R1	160,00

Colours: bianco



Special colours on request

Weight:
Underground base
net kg 5,50

Stake mounted
net kg 5,20

Base
net kg 10,10

Halo, Fluo, LED retrofit light bulbs not included
→ specifications p. 170

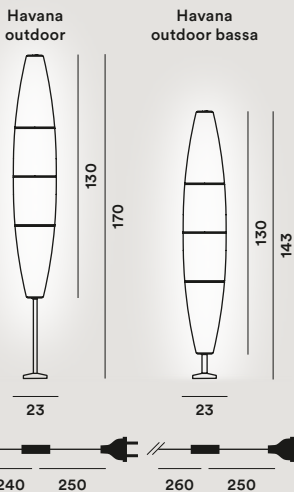
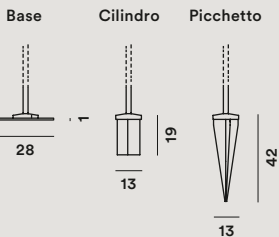

collection →

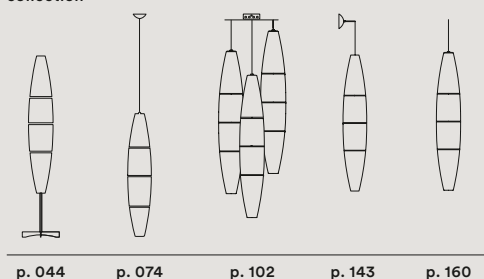

IP 44



IP 65



base

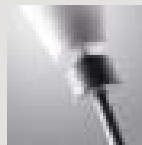

cilindro



picchetto



Solar

Jean Marie Massaud, 2011



	energy cl.	colours	code	vat excluded
<i>Solar</i>	A ⁺ , A	marrone	228003M	733,00
Spare parts:				
<i>Lampshade Solar</i>		bianco	228S11 10	225,00
<i>Top disk Solar</i>		marrone	228S101M	337,00

Rotational moulded polyethylene, porcelain stoneware top shelf

Colours: marrone



Weight: net kg 11,70

Fluo, LED retrofit light bulbs not included → specifications p. 170

LED retrofit / Fluo
1x25W E27

Reclinable up to 15°

☐ ▼ CE ◀ IP 65 IP 44

Tecnico — 2016

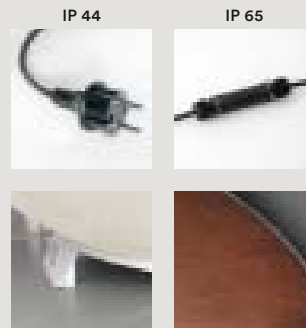
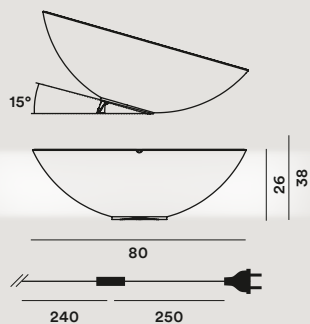

Gregg outdoor

sospensione

Ludovica e Roberto Palomba,
2011

Rotational moulded
polyethylene and coated
metal

X-large / grande
LED retrofit / Fluo
1x25W E27

media
LED retrofit / Fluo
1x15W E27

Canopy not included

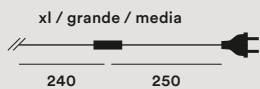
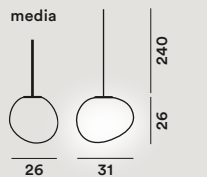
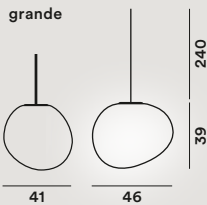
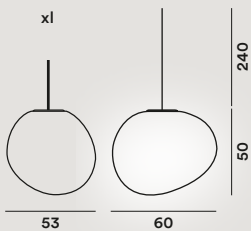

	energy	cl.	colours	code	vat excluded
<i>Gregg outdoor X-large</i>	A ⁺	A	bianco	218007 10	307,00
<i>Gregg outdoor X-large H. 5 m</i>	A ⁺	A	bianco	218007SP5 10	336,00
<i>Gregg outdoor grande</i>	A ⁺	A	bianco	218017 10	229,00
<i>Gregg outdoor grande H. 5 m</i>	A ⁺	A	bianco	218017SP5 10	258,00
<i>Gregg outdoor media</i>	A ⁺	A	bianco	218027 10	183,00
<i>Gregg outdoor media H. 5 m</i>	A ⁺	A	bianco	218027SP5 10	212,00

Spare parts:

<i>Lampshade Gregg outdoor X-large</i>	bianco	218S001 10	179,00
<i>Lampshade Gregg outdoor grande</i>	bianco	218S00 10	101,00
<i>Lampshade Gregg outdoor media</i>	bianco	218S002 10	63,00

Colours: bianco



Weight:
X-large
net kg 3,70

grande
net kg 3,00

media
net kg 1,40

Fluo, LED retrofit light
bulbs not included
→ specifications p. 170

collection →

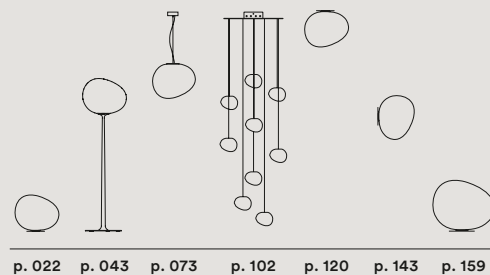

IP 44



IP 65



Havana outdoor

sospensione

Jozeph Forakis, 2005

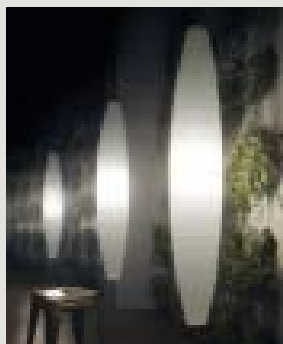

	energy cl.	colours	code	vat excluded
<i>Havana outdoor</i>	A+, A, B, C	bianco	150007 10	315,00
<i>Havana outdoor H. 5 m</i>	A+, A, B, C	bianco	150007 10 SP5	356,00

Spare parts:

<i>Lampshade Havana Outdoor</i>	bianco	150S00 10	148,00
---------------------------------	--------	-----------	--------

Rotational moulded polyethylene and coated metal

LED retrofit / Fluo
1x15W E27
Halo 1x46W E27

Canopy not included

☐ ▼ CE ◀ IP 65 IP 44

Colours: bianco



Weight:
net kg 3,00

Halo, Fluo, LED retrofit
light bulbs not included
→ specifications p. 170

Tecnico — 2016

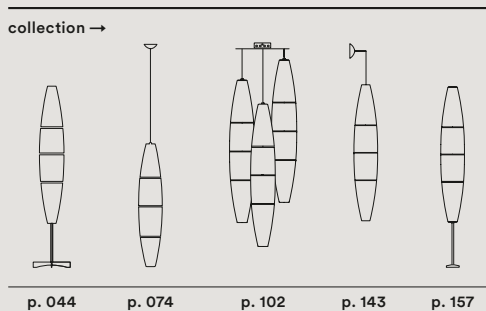
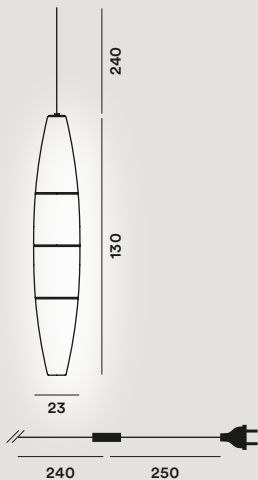

Uto

Lagranja Design, 2005

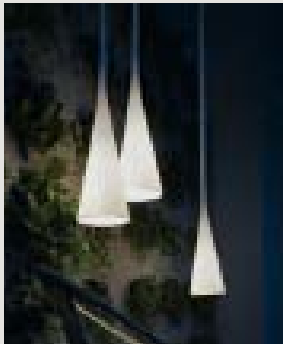

	energy cl.	colours	code	vat excluded
Uto	A ⁺ , A	bianco	142000 10	319,00
		giallo	142000 50	
		arancio	142000 53	

Thermoplastic elastomer and polycarbonate

LED retrofit / Fluo
1x15W E27

Switch inside the flexible tube

☐ ▽ CE ◀ IP 44

Colours: bianco, giallo, arancio

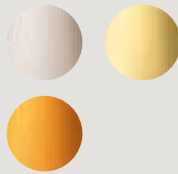

Special colours on request

Weight:
net kg 2,00

Fluo, LED retrofit light bulbs not included
→ specifications p. 170

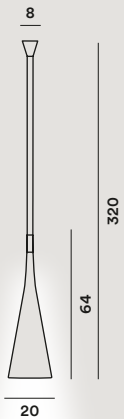

collection →



p. 034

p. 097



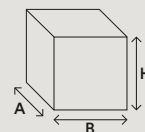

Packing

Model	Version		N° boxes	Description	net weight kg	gross weight kg	size cm A x B x H	vol m ³		
Allegretto	<i>Assai</i>	sospensione	1	set rodes	8,7	13,0	91x61x29	0,161		
			1	frame	2,6	5,0	47x47x34	0,075		
	<i>Ritmico</i>	sospensione	1	set rodes	2,7	4,5	66x41x25	0,068		
			1	frame	2,4	4,7	47x47x34	0,075		
	<i>Vivace</i>	sospensione	1	set rodes	6,4	8,7	84x39x27	0,090		
			1	frame	2,7	5,1	47x47x34	0,075		
Allegro	<i>Assai</i>	sospensione	1	set rodes	31,0	46,5	187x37x27	0,190		
			1	frame	5,0	6,3	43x43x34	0,062		
	<i>Ritmico</i>	sospensione	1	set rodes	10,0	11,9	97x53x25	0,128		
			1	frame	5,0	6,3	43x43x34	0,062		
	<i>Vivace</i>	sospensione	1	set rodes	14,3	16,7	111x44x27	0,131		
			1	frame	5,0	6,3	43x43x34	0,062		
Anisha	<i>piccola</i>	tavolo	1		0,4	1,2	41x29x10	0,013		
	<i>grande</i>	tavolo	1		0,7	1,7	51x37x10	0,021		
Aplomb		sospensione	1		1,9	2,9	29x29x51	0,039		
	<i>mini</i>	sospensione	1		1,9	2,9	36x19x16	0,011		
		terra	1	frame + diffuser	3,2	7,7	28x28x197	0,154		
			1	base	5,3	6,5	43x32x8	0,011		
		parete	1		2,0	3,0	35x28x20	0,020		
Bahia	<i>Fluo</i>	parete/soffitto	1		3,4	4,5	86x81x16	0,111		
	<i>LED</i>	parete	1		4,0	5,1	86x81x16	0,111		
	<i>mini</i>	parete/soffitto	1		2,0	4,3	62x62x18	0,069		
	<i>mini LED</i>	parete/soffitto	1		2,3	4,6	62x62x18	0,069		
Behive		sospensione	1	diffuser	2,3	4,7	49x49x41	0,098		
			1	frame	0,8	1,7	25x23x27	0,016		
		tavolo	1	diffuser	2,2	4,6	49x49x41	0,098		
			1	frame	1,5	2,2	21x21x34	0,015		
Big Bang		parete/soffitto	1	diffuser set	2,0	3,1	89x31x12	0,033		
			1	frame	1,0	1,4	23x23x9	0,005		
	<i>Halo</i>	sospensione	1	diffuser set	3,4	4,4	89x31x12	0,033		
			1	frame	2,0	3,3	89x31x12	0,033		
	<i>LED</i>	sospensione	1	diffuser set	3,4	4,4	89x31x12	0,033		
			1	frame	4,0	5,5	89x31x12	0,033		
Big Bang xl		sospensione	1	diffuser set	23,0	30,0	193x48x17	0,160		
			1	frame	12,0	15,0	131x58x50	0,380		
Binic		tavolo	1		1,2	2,7	19x19x23	0,010		
Birdie	<i>1</i>	soffitto	1	diffuser	0,4	0,8	23x23x26	0,014		
			1	canopy	0,6	1,0	18x18x8	0,002		
			1	frame	0,5	2,3	100x28x18	0,050		
		<i>3</i>	soffitto	3	diffuser	0,4	0,8	23x23x26	0,014	
				1	canopy	1,0	2,0	24x24x14	0,008	
				1	set 3 arms	1,5	5,1	106x59x18	0,112	
	<i>6</i>	soffitto	6	diffuser	0,4	0,8	23x23x26	0,014		
			1	canopy	1,2	2,0	24x24x14	0,008		
			2	set 3 arms	1,5	5,1	106x59x18	0,112		
	<i>9</i>	soffitto	9	diffuser	0,4	0,8	23x23x26	0,014		
			1	canopy	1,4	2,0	24x24x14	0,008		
			3	set 3 arms	1,5	5,1	106x59x18	0,112		
	<i>6</i>	sospensione	6	diffuser	0,4	0,8	23x23x26	0,014		
			1	canopy	1,2	1,7	20x19x20	0,008		
			2	set 3 arms	1,5	5,1	106x59x18	0,112		
			9	sospensione	9	diffuser	0,4	0,8	23x23x26	0,014
			1	canopy	1,4	1,9	20x19x20	0,008		
			3	set 3 arms	1,5	5,1	106x59x18	0,112		
<i>grande</i>	tavolo	1	diffuser	0,7	1,5	30x30x35	0,035			
		1	frame	3,3	5,4	79x30x27	0,063			
		1	diffuser	0,4	0,8	23x23x26	0,014			
	<i>piccola</i>	tavolo	1	diffuser	0,4	0,8	23x23x26	0,014		
			1	frame	1,6	3,0	26x26x53	0,036		

Model	Version		N° boxes	Description	net weight kg	gross weight kg	size cm A x B x H	vol m ³	
<i>Birdie</i>	<i>grande</i>	sospensione	1	diffuser	0,7	1,5	30x30x35	0,035	
			1	frame	0,7	1,7	20x20x29	0,012	
	<i>piccola</i>	sospensione	1	diffuser	0,4	0,8	23x23x26	0,014	
			1	frame	0,7	1,5	17x17x24	0,007	
		lettura	1	diffuser	0,7	1,5	30x30x35	0,035	
			1	frame	3,6	7,8	159x29x27	0,124	
		parete	1	diffuser	0,4	0,8	23x23x26	0,014	
			1	frame	1,2	2,5	50x20x29	0,029	
	<i>Metal grande</i>	tavolo	1		3,8	7,5	82x82x37	0,115	
	<i>Metal piccola</i>	tavolo	1		2,0	3,9	59x27x27	0,043	
	<i>Bit</i>	1	parete	1	glass	1,1	2,3	61x52x11	0,040
				1	frame	0,6	1,0	19x19x14	0,005
2		parete	1	glass	0,4	2,3	51x37x11	0,025	
			1	frame	0,6	1,0	19x19x14	0,005	
3		parete	1	glass	1,2	2,3	61x52x11	0,040	
			1	frame	0,6	1,0	19x19x14	0,005	
4		parete	1	glass	0,6	2,3	51x37x11	0,025	
			1	frame	0,6	1,0	19x19x14	0,005	
5		parete	1	glass	0,8	2,3	51x37x11	0,025	
			1	frame	0,6	1,0	19x19x14	0,005	
<i>Blob s</i>		parete/soffitto	1	diffuser	0,6	0,9	48x17x17	0,014	
			1	frame	0,5	0,8	46x12x8	0,005	
<i>Caboche</i>		<i>grande Halo</i>	sospensione	1	set sphere	12,1	13,5	51x51x15	0,045
				1	frame	7,5	9,0	69x69x38	0,181
		<i>grande LED</i>	sospensione	1	set sphere	12,1	13,5	51x51x15	0,045
	1			frame	4,9	7,7	69x69x38	0,181	
	1			set sphere	12,1	13,5	51x51x15	0,045	
	1			frame	10,5	12,4	69x69x52	0,248	
	<i>media Halo</i>	sospensione	1	set stem	1,3	2,0	155x11x12	0,021	
			1	set sphere	6,4	7,2	38x38x14	0,021	
	<i>media LED</i>	sospensione	1	frame	3,8	4,9	52x52x28	0,076	
			1	set sphere	6,4	7,2	38x38x14	0,021	
	<i>media</i>	parete	1	frame	3,8	5,1	52x52x28	0,076	
			1	set sphere	2,7	3,5	31x26x15	0,013	
		terra	1	frame	1,8	2,6	45x17x38	0,030	
			1	set sphere	6,4	7,2	38x38x14	0,021	
	<i>piccola</i>	parete	1	frame	4,4	6,5	51x51x36	0,094	
			1	set stem	1,0	1,7	155x11x12	0,021	
			1	set sphere	1,5	2,2	34x20x11	0,008	
			1	frame	1,1	2,0	18x29x32	0,017	
		sospensione	1	set sphere	3,2	3,8	47x24x11	0,013	
			1	frame	1,6	2,0	29x29x38	0,032	
		tavolo	1	set sphere	3,2	3,8	47x24x11	0,013	
			1	frame	2,1	2,5	29x29x51	0,039	
<i>soffitto</i>		1	set sphere	5,2	6,4	38x35x15	0,020		
<i>Chouchin reverse</i>	1	sospensione	1	glass	3,7	5,4	51x51x44	0,114	
			1	frame	0,7	0,8	19x19x14	0,005	
	2	sospensione	1	glass	2,2	3,6	34x34x55	0,070	
			1	frame	0,7	1,0	19x19x14	0,005	
	3	sospensione	1	glass	2,9	3,6	38x38x33	0,046	
			1	frame	0,7	0,8	19x19x14	0,005	
<i>Chouchin mini</i>	1	sospensione	1		1,0	1,6	28x22x19	0,012	
	2	sospensione	1		1,1	1,6	35x18x24	0,015	
<i>Circus</i>	<i>grande</i>	parete/soffitto	1	glass	3,0	4,4	51x51x15	0,045	
			1	frame	1,7	2,7	42x42x17	0,030	
	<i>piccola</i>	parete/soffitto	1	glass	1,6	2,0	42x42x17	0,030	
			1	frame	0,5	0,7	19x19x14	0,005	

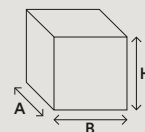

Packing

Model	Version	N° boxes	Description	net weight kg	gross weight kg	size cm A x B x H	vol m ³		
<i>Colibri</i>	lettura	1	frame+diffuser	1,4	4,0	152x23x23	0,080		
		1	base	3,7	4,6	34x34x12	0,014		
<i>Doll</i>	tavolo	1		0,7	1,4	22x22x29	0,014		
<i>Double</i>	parete	1	diffuser	1,5	1,9	37x34x21	0,021		
		1	frame	0,5	0,7	25x15x10	0,005		
<i>Ellepi</i>	parete/soffitto	1	diffuser	2,0	3,5	82x72x17	0,110		
		1	frame	2,3	3,5	61x51x17	0,057		
<i>Esa</i>	<i>grande</i>	tavolo	1	glass	2,0	3,0	52x37x27	0,046	
			1	frame	1,2	2,0	52x37x27	0,046	
	<i>piccola</i>	tavolo	1	glass	1,7	1,7	34x22x23	0,020	
			1	frame	0,6	1,0	27x22x32	0,019	
<i>Falena</i>	1	parete	1	0,8	1,1	31x17x15	0,008		
	2	parete/soffitto	1	3,0	3,8	86x17x15	0,022		
	3	parete/soffitto	1	5,2	6,2	145x17x15	0,037		
<i>Fields</i>	1	parete	1	6,0	8,0	177x22x14	0,054		
		parete	1	1,3	1,5	76x25x4	0,008		
	3		1	frame	5,2	7,5	134x25x31	0,104	
		parete	1	diffuser set	1,3	1,6	60x32x3	0,005	
		1	frame	4,5	6,1	104x25x25	0,065		
<i>Flip</i>	parete	1		1,2	2,3	40x37x23	0,034		
<i>Folio</i>	<i>grande</i>	parete	1	glass	1,6	3,0	62x52x18	0,058	
			1	frame	0,6	0,9	56x13x10	0,010	
		soffitto	1	glass	1,6	3,0	62x52x18	0,058	
	<i>piccola</i>		1	frame	0,6	1,1	57x27x11	0,020	
		parete	1	glass	1,0	1,3	38x35x15	0,020	
			1	frame	0,6	0,9	56x13x10	0,010	
<i>Giga-Lite</i>	sospensione	1	diffuser	1,5	2,7	57x57x46	0,150		
		1	frame	1,0	1,6	29x27x23	0,020		
	terra	1	diffuser	1,5	2,7	57x57x46	0,150		
		1	frame	8,3	10,9	144x30x14	0,061		
<i>Gregg</i>	<i>grande</i>	sospensione	1	glass	5,0	7,0	56x48x47	0,127	
			1	frame	0,6	0,7	19x19x14	0,005	
		tavolo	1	glass	5,0	7,0	56x48x47	0,127	
	<i>grande alta</i>		1	frame	1,8	2,5	23x23x19	0,010	
		terra	1	glass	5,0	7,0	56x48x47	0,127	
				1	base	7,2	8,3	55x55x3	0,009
				1	frame	2,5	5,0	166x20x20	0,066
		<i>media alta</i>	terra	1	glass	2,5	2,8	38x33x30	0,038
				1	base	7,2	8,3	55x55x3	0,009
			1	frame	2,5	5,0	166x20x20	0,066	
	<i>media</i>	parete/soffitto	1	glass	2,5	2,8	38x33x30	0,038	
			1	frame	0,4	0,7	19x19x18	0,007	
		sospensione	1	glass	2,5	2,8	38x33x30	0,038	
			1	frame	0,6	0,7	19x19x14	0,005	
		tavolo	1	glass	2,5	2,8	38x33x30	0,038	
			1	frame	0,8	1,2	19x19x18	0,007	
<i>piccola</i>		parete/soffitto	1		0,6	0,9	27x19x20	0,011	
		sospensione	1		0,7	0,9	27x19x20	0,011	
	tavolo	1		0,6	0,9	27x19x20	0,011		
<i>Havana outdoor</i>	sospensione	1	diffuser	2,0	3,3	25x25x132	0,083		
			1	frame	1,0	1,4	64x13x10	0,008	
		<i>base</i>	terra	1	diffuser	2,0	3,3	25x25x132	0,083
	<i>cilindro</i>		1	base	6,1	6,2	37x37x3	0,004	
			1	frame	2,0	2,9	107x14x14	0,021	
		terra	1	diffuser	2,0	3,3	25x25x132	0,083	
				1	underground base	0,5	0,7	15x14x24	0,005
				1	frame	3,0	4,0	107x14x14	0,021

Model		Version	N° boxes	Description	net weight kg	gross weight kg	size cm A x B x H	vol m ³
<i>Havana outdoor</i>	<i>picchetto</i>	terra	1	diffuser	2,0	3,3	25x25x132	0,083
			1	stake mounted	1,2	1,5	14x13x46	0,010
			1	frame	2,0	2,5	107x14x14	0,021
	<i>bassa base</i>	terra	1	diffuser	2,0	3,3	25x25x132	0,083
			1	base	6,1	6,5	37x37x3	0,004
			1	frame	2,0	2,5	107x14x14	0,021
	<i>bassa cilindro</i>	terra	1	diffuser	2,0	3,3	25x25x132	0,083
			1	underground base	0,5	0,7	15x14x24	0,005
			1	frame	3,0	3,5	107x14x14	0,021
	<i>bassa picchetto</i>	terra	1	diffuser	2,0	3,3	25x25x132	0,083
			1	stake mounted	1,2	1,5	14x13x46	0,010
			1	frame	1,5	2,4	107x14x14	0,021
<i>Havana</i>	sospensione/parete		1	diffuser set	1,3	1,8	49x25x25	0,040
			1	frame	0,6	0,8	19x19x14	0,005
	terra		1	diffuser set	1,3	1,8	49x25x25	0,040
			1	frame	2,0	3,0	100x29x15	0,050
<i>Innerlight</i>	parete		1	diffuser set	3,3	4,3	79x20x26	0,041
			1	frame	1,7	3,0	69x30x16	0,033
<i>Jamaica</i>	sospensione		1	diffuser set	2,3	5,9	81x81x27	0,177
			1	frame	3,7	5,4	174x15x20	0,052
<i>Kite</i>	parete		1	diffuser	0,3	1,3	52x37x27	0,046
			1	frame	0,2	0,9	26x16x11	0,010
<i>Lake</i>	parete		1	diffuser	1,3	2,5	58x50x12	0,035
			1	frame	0,4	0,7	18x18x17	0,005
<i>Le Soleil</i>	parete		1	diffuser set	0,8	1,5	38x31x12	0,014
			1	frame	0,8	1,3	28x22x11	0,007
	sospensione		1	diffuser set	4,1	6,0	61x61x23	0,085
			1	frame	1,2	2,2	25x25x33	0,016
<i>Lightweight</i>	sospensione		1		7,6	21,6	113x112x82	1,040
<i>Lightwing</i>	terra		1	frame+diffuser	6,0	14,0	185x40x44	0,325
			1	base	5,0	6,0	30x30x12	0,010
<i>Lumiere</i>	<i>grande</i>	tavolo	1	glass	1,5	2,1	33x33x26	0,028
			1	frame	0,9	1,4	49x25x25	0,040
	<i>piccola</i>	tavolo	1	glass	0,6	1,2	26x26x21	0,014
<i>Lumiere xxl</i>	parete/soffitto		1	glass	1,8	2,1	41x41x20	0,033
			1	frame	1,6	3,0	42x42x17	0,030
	tavolo		1	glass	4,0	5,3	50x50x37	0,100
			1	frame	1,5	2,8	38x38x61	0,088
<i>Lumiere xxs</i>	parete/soffitto		1	glass	1,0	1,6	31x31x17	0,016
			1	frame	0,8	1,7	30x30x10	0,009
	tavolo		1	glass	1,2	2,3	33x33x26	0,028
			1	frame	0,6	1,7	43x27x27	0,031
			1	lettura	2,8	5,0	130x24x5	0,021
			1	tavolo	1,3	1,8	41x24x7	0,007
<i>Maki</i>	sospensione		1		0,5	0,8	31x17x15	0,008
<i>Mite</i>	terra		1		7,0	11,1	28x28x197	0,154
<i>New Buds</i>	1	sospensione	1	glass	2,5	5,3	36x36x63	0,082
			1	frame	0,7	0,9	19x19x14	0,005
<i>New Buds</i>	2	sospensione	1	glass	3,5	5,0	50x50x37	0,100
			1	frame	0,7	0,9	19x19x14	0,005
<i>New Buds</i>	3	sospensione	1	glass	2,5	3,5	38x38x33	0,046
			1	frame	0,7	0,9	19x19x14	0,005
<i>Nuage</i>	parete/soffitto		1	diffuser set	1,4	3,6	71x71x16	0,081
			1	frame	1,8	3,0	41x41x13	0,022
<i>Orbital</i>	terra		1	glass set	4,1	5,5	71x52x13	0,048
			1	frame	6,0	9,7	185x32x27	0,160

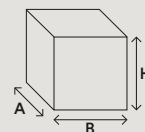

Packing

Model	Version	N° boxes	Description	net weight kg	gross weight kg	size cm A x B x H	vol m ³
O-Space							
	sospensione	1		4,4	6,0	67×55×42	0,155
Gregg outdoor	grande	sospensione	1 diffuser	2,3	3,5	50×42×39	0,082
			1 frame	0,7	1,2	20×17×26	0,009
	terra	1 diffuser		2,3	3,5	50×42×39	0,082
		1 frame		1,3	1,9	28×28×15	0,012
	media	sospensione	1 diffuser	0,7	1,4	33×28×26	0,024
			1 frame		0,7	1,5	20×17×26
	terra	1 diffuser		0,7	1,4	33×28×26	0,024
		1 frame		0,9	1,5	21×21×15	0,007
	xl	sospensione	1 diffuser	3,0	5,4	63×53×50	0,167
			1 frame		0,7	1,2	20×17×26
	terra	1 diffuser		3,0	5,4	63×53×50	0,167
		1 frame		1,3	1,9	28×28×15	0,012
Planet	grande	sospensione	1 diffuser	1,1	4,4	81×81×41	0,269
			1 frame	1,4	2,6	29×29×32	0,027
	piccola	sospensione	1 diffuser	0,6	2,2	56×56×26	0,081
			1 frame		1,4	2,6	29×29×32
Plass	grande	sospensione	1 diffuser	18,0	24,0	119×79×79	0,742
			1 frame	5,0	10,0	129×31×31	0,115
	media	sospensione	1 diffuser	2,8	3,5	36×36×52	0,007
			1 frame		0,7	1,2	47×44×14
	tavolo	1 diffuser		2,8	3,5	36×36×52	0,067
		1 frame		1,2	2,0	22×22×32	0,016
Polygregg	grande	tavolo	1 diffuser	2,3	3,5	50×42×39	0,082
			1 frame	1,3	1,9	28×28×15	0,012
	media	tavolo	1 diffuser	0,7	1,4	33×28×26	0,024
			1 frame		0,9	1,4	21×21×15
	xl	tavolo	1 diffuser	3,0	5,4	63×53×50	0,167
			1 frame		1,3	1,9	28×28×15
Rituals	1	parete	1 glass	3,4	4,0	33×33×40	0,049
			1 frame	1,4	2,0	28×19×18	0,010
		soffitto	1 glass	3,4	4,0	33×33×40	0,049
			1 frame	0,7	1,1	19×19×21	0,080
		sospensione	1 glass	3,4	4,0	33×33×40	0,043
			1 frame	0,5	0,8	19×19×14	0,005
	tavolo	1 glass	3,4	4,0	33×33×40	0,043	
		1 frame	0,6	1,2	26×25×18	0,012	
	2	soffitto	1 glass	3,5	4,0	41×41×26	0,043
			1 frame	0,7	1,01	19×19×21	0,080
		sospensione	1 glass	3,5	4,0	41×41×26	0,043
			1 frame	0,5	0,8	19×19×14	0,005
tavolo		1 glass	3,5	4,0	41×41×26	0,043	
		1 frame	0,6	1,2	26×25×18	0,012	
3	parete	1 glass	1,0	1,6	25×25×26	0,016	
		1 frame	1,4	2,0	28×19×18	0,010	
	soffitto	1 glass	1,0	1,6	25×25×26	0,016	
		1 frame	0,7	1,1	19×19×21	0,080	
	sospensione	1 glass	1,0	1,6	25×25×26	0,016	
		1 frame	0,5	0,8	19×19×14	0,005	
tavolo	1 glass	1,0	1,6	25×25×26	0,016		
	1 frame	0,6	1,2	26×25×18	0,012		
xl	tavolo	1 diffuser	5,4	8,4	51×54×50	0,130	
		1 frame	1,2	2,0	22×22×32	0,016	
	sospensione	1 diffuser	5,4	8,4	51×54×50	0,130	
		1 frame	0,6	0,7	19×19×14	0,005	
Solar outdoor	terra	1 diffuser	9,4	13,7	87×87×27	0,197	
		1 frame	2,3	3,6	31×31×17	0,016	

Model		Version	N° boxes	Description	net weight kg	gross weight kg	size cm A x B x H	vol m ³
Spokes	1	sospensione	1	canopy	1,2	2,2	22x22x8	0,004
			1	structure	3,2	6,2	80x40x40	0,128
	2	sospensione	1	canopy	1,2	2,2	22x22x8	0,004
			1	structure	3,2	7,4	60x60x61	0,22
Supernova		sospensione	1		8,0	10,6	82x72x17	0,110
Tartan		sospensione	1	diffuser	4,0	6,5	49x49x44	0,106
			1	frame	0,7	0,9	19x19x14	0,005
Tite	1	sospensione	1	diffuser	0,8	2,0	123x29x30	0,107
			1	frame	0,6	1,2	80x16x14	0,018
	2	sospensione	1	diffuser	0,5	1,1	64x27x27	0,046
			1	frame	0,5	1,1	45x16x14	0,011
Tivù	grande	parete/soffitto	1		1,3	2,0	46x27x13	0,019
	piccola	parete	1		0,3	0,7	22x17x11	0,004
Tress	grande	parete	1	diffuser	0,4	1,6	68x32x19	0,041
			1	frame	0,7	0,9	36x12x9	0,004
		sospensione	1	diffuser	1,1	2,9	51x51x44	0,114
			1	frame	2,8	3,7	46x46x23	0,048
	grande LED	sospensione	1	diffuser	1,1	2,9	51x51x44	0,114
			1	frame	2,0	3,3	89x31x12	0,033
		terra	1	frame+diffuser	5,0	8,5	200x30x34	0,204
			1	base	6,5	6,0	26x26x3	0,002
	grande Halo	terra	1	frame+diffuser	3,0	7,0	200x30x34	0,204
			1	base	5,5	6,0	26x26x3	0,002
	media	sospensione	1	diffuser	1,6	3,5	118x30x30	0,106
			1	frame	0,8	1,0	21x21x15	0,007
		terra	1	diffuser	1,6	3,5	118x30x30	0,106
			1	frame	2,3	2,5	28x28x15	0,012
		tavolo	1	diffuser	0,9	1,8	61x61x23	0,085
			1	frame	2,3	2,5	28x28x15	0,012
piccola		parete	1	diffuser	0,3	1,5	48x32x19	0,029
			1	frame	0,7	0,9	36x12x9	0,004
	sospensione	1	diffuser	0,9	1,8	61x61x23	0,085	
		1	frame	0,8	1,0	21x21x15	0,007	
mini	sospensione	1	diffuser	0,4	1,4	52x26x26	0,035	
		1	frame	0,7	0,8	19x19x14	0,005	
	tavolo	1	diffuser	0,4	1,4	52x26x26	0,035	
		1	frame	1,0	2,0	21x21x15	0,007	
Tress Stilo	sospensione	1		0,5	1,2	76x12x12	0,011	
	terra	1	frame+diffuser	1,6	4,5	205x21x21	0,090	
		1	base	2,6	2,9	30x30x4	0,004	
Troag	grande	sospensione	1		3,5	6,0	227x16x15	0,054
	media	sospensione	1		2,8	5,2	197x16x15	0,047
	piccola	sospensione	1		1,8	3,9	137x16x15	0,033
Tropico	Ellipse	sospensione	1	set elements	3,8	4,5	38x38x11	0,014
			1	set rings	1,3	2,6	72x72x6	0,031
			1	frame	1,0	2,7	52x26x26	0,035
			1	set of filters	0,5	0,3	48x6x6	0,002
	Sphera	sospensione	1	set elements	3,3	4,5	38x38x11	0,014
			1	set rings	1,7	2,5	63x63x6	0,240
			1	frame	1,0	3,3	73x26x26	0,050
			1	set of filters	0,5	0,3	48x6x6	0,002
	Vertical	sospensione	1	set elements	3,8	4,5	38x38x11	0,014
			1	set rings	2,9	3,5	33x33x15	0,014
1			frame	1,0	5,2	161x26x26	0,108	
1			set of filters	0,5	0,3	48x6x6	0,002	
Tuareg	terra	1	structure	2,8	4,2	87x87x106	0,802	
		1	base	6,4	8,8	157x24x17	0,065	

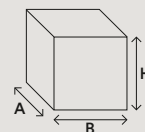
Packing

Model	Version	N° boxes	Description	net weight kg	gross weight kg	size cm A x B x H	vol m ³
<i>Tutù</i>	parete	1	glass	0,5	1,2	37×18×24	0,160
		1	frame	0,4	0,7	36×12×9	0,004
<i>Twiggy</i>	sospensione	1	diffuser	1,6	2,8	51×51×32	0,083
		1	frame	0,8	1,1	56×16×17	0,016
	lettura	1	diffuser	1,0	2,9	51×51×32	0,083
		1	frame	1,5	3,0	164×21×22	0,075
		1	base	8,3	8,7	55×55×6	0,018
	soffitto	1	diffuser	1,6	2,8	51×51×32	0,083
		1	frame	4,0	6,0	194×30×18	0,105
	terra	1	diffuser	1,6	2,8	51×51×32	0,083
		1	frame	1,5	3,9	187×21×23	0,090
		1	base	13,5	15,3	69×69×7	0,034
<i>LED</i>		1	stem set	0,1	0,4	96×6×7	0,004
	terra	1	diffuser	1,6	3,5	51×51×32	0,083
		1	frame	2,0	3,0	171×19×12	0,041
		1	base	13,5	15,3	69×69×7	0,034
<i>Twiggy xl</i>	tavolo	1	diffuser	1,0	3,0	51×51×32	0,083
		1	frame	1,1	1,5	68×21×22	0,030
		1	base	4,7	5,5	45×45×6	0,012
<i>Uto</i>		1		2,0	3,4	80×30×22	0,053
<i>Wave</i>	sospensione	1		6,0	10,7	237×50×18	0,213
<i>Yoko</i>	tavolo	1	diffuser	0,6	1,0	25×25×33	0,016
		1	frame	1,4	2,1	38×21×21	0,017
Accessories							
<i>Multiple canopy</i>	<i>tondo</i>	1		9,0	10,7	61×61×9	0,034
	<i>lineare 90</i>	1		6,8	7,7	100×27×9	0,025
	<i>lineare 135</i>	1		10,0	11,5	145×27×9	0,036

Light Sources







The light tones may vary from one lamp bulb to another. Foscarini recommends the use of warm light bulbs for its entire collection.







Light bulbs which are readily available for purchase may feature technical specifications with various graphics and definitions, but a warm light tone is generally described as:

Warm White - 2700- 3000K° and CRI > 80 for halogen / LED retrofit light bulbs
light colour 827 and CRI >80 for fluorescent light bulbs.

This table contains the necessary information to purchase the correct light source (Foscarini models with integrated LED excluded).

* Expressed in mm

Model	Version	Type	Fitting Base	Length*	Width*	Notes
<i>Allegretto</i>	sospensione	Halo / LED retrofit	E27-PAR	max 85	Ø96	
<i>Allegro</i>	sospensione	Halo	E27-PAR / R7s	max 99 (E27 PAR) 118 (R7s)	Ø96	
<i>Aplomb -Aplomb mini</i>	sospensione	LED retrofit	GU10-PAR	max 80	Ø80	
<i>Aplomb</i>	sospensione	Halo	G9			
<i>Aplomb</i>	terra	Halo	R7s	78	//	
<i>Bahia-Bahia mini</i>	soffitto/parete	Fluo	2GX13 T16-R	300/230	Ø16	
<i>Behive</i>	tavolo	Halo	E27		max Ø65	
<i>Behive</i>	sospensione	LED retrofit / Fluo / Halo	E27		max Ø65	
<i>Big Bang</i>	sospensione	Halo	R7s	118		
<i>Big Bang</i>	sospensione	Fluo	GX24q-3	max 150	max Ø50	
<i>Big Bang</i>	soffitto/parete	Halo	R7s	78	//	
<i>Binic</i>	tavolo	LED retrofit / Fluo	E14	max 110	max Ø40	
<i>Birdie</i>	tavolo grande /terra /sosp gr.	LED retrofit / Fluo / Halo	E27	max 180	max Ø120	
<i>Birdie</i>	tav. piccolo /sosp./soff./par.	LED retrofit / Fluo / Halo	E27	max 110	max Ø80	
<i>Bit</i>	parete	LED retrofit / Fluo / Halo	E14	max 140	max Ø45	
<i>Blob</i>	soffitto/parete	Fluo	2G11	max 533	Ø34	
<i>Caboche</i>	sospensione piccola/tavolo	Halo	G9			
<i>Caboche</i>	terra/sospensione/soffitto	Halo	R7s	118		
<i>Caboche</i>	parete	Halo	R7s	78		
<i>Caiigo</i>	sospensione	LED retrofit / Halo	GU10-PAR	max 62	max Ø51	
<i>Chouchin 1-2-3 & reverse</i>	sospensione	LED retrofit / Fluo / Halo	E27/E27 PAR	max 150	max Ø100	
<i>Chouchin mini</i>	sospensione	LED retrofit / Halo	GU10-PAR	max 60	max Ø55	
<i>Circus grande</i>	soffitto/parete	LED retrofit / Fluo / Halo	E27	max 100	max Ø70	
<i>Circus piccola</i>	soffitto/parete	LED retrofit / Fluo / Halo	E14	max 70	max Ø50	
<i>Colibri</i>	terra	Halo	GU10-PAR	max 65	max Ø65	
<i>Doll</i>	tavolo	LED retrofit / Fluo	E14	max 110	max Ø60	
<i>Double</i>	parete	LED retrofit / Fluo / Halo	E27	max 110	max Ø60	
<i>Ellepi</i>	soffitto/parete	Fluo	2GX13 T16-R	300	Ø16	
<i>Esa grande</i>	tavolo	LED retrofit / Fluo / Halo	E14	max 130	max Ø66	
<i>Esa piccola</i>	tavolo	Halo	G9			
<i>Falena 1</i>	parete	Halo	R7s	78		
<i>Falena 2-3</i>	soffitto/parete	Fluo	G5	1149/849	Ø16	
<i>Fields 1-2-3</i>	parete	Fluo	G5	1449/1149/849	Ø16	
<i>Flip</i>	parete	Halo	R7s	78		
<i>Folio grande piccola</i>	soffitto/parete	Halo	R7s	78		
<i>Folio grande piccola</i>	soffitto/parete	Fluo	2G11	max 533	Ø34	
<i>Giga-Lite</i>	terra/sospensione	LED retrofit / Fluo / Halo	E27	max 150	max Ø80	
<i>Gregg grande</i>	tavolo/sospensione/terra	LED retrofit / Fluo / Halo	E27	max 140	max Ø60	
<i>Gregg media</i>	tavolo/terra/sosp./soff./par.	LED retrofit / Fluo / Halo	E27	max 140	max Ø60	
<i>Gregg piccola</i>	tavolo/sosp./soffitto/parete	Halo	G9			
<i>Havana</i>	terra/sospensione/parete	LED retrofit / Fluo / Halo	E27	max 125	max Ø60	
<i>Havana outdoor</i>	terra/sospensione	LED retrofit / Fluo / Halo	E27		max Ø55	
<i>Innerlight</i>	parete	Fluo	2G11	max 533	Ø34	
<i>Kite</i>	parete	LED retrofit / Fluo / Halo	E14		max Ø50	
<i>Kurage</i>	tavolo		E27	max 135	max Ø65	
<i>Jamaica</i>	sospensione	Fluo	G5	1449	Ø16	

Model	Version	Type	Fitting Base	Lenght*	Width*	Notes
<i>Le Soleil</i>	sospensione	Halo	G9/GU10 PAR			
<i>Le Soleil</i>	sospensione	Fluo	GX24q-4	max 168	max Ø49	
<i>Le Soleil</i>	parete	Fluo	GX24q-3	max 150	max Ø50	
<i>Lightweight</i>	sospensione	Halo	G4 12v			
<i>Lumiere grande piccola</i>	tavolo	Halo	G9			
<i>Lumiere xxl xxs</i>	tavolo	Halo	G9			
<i>Lumiere xxl</i>	soffitto/parete	Fluo	2GX13 T16-R	300	Ø16	
<i>Lumiere xxs</i>	soffitto/parete	Fluo	2G24q-2	max 130	Ø34	
<i>Maki</i>	sospensione	LED retrofit / Halo	GU10-PAR		max Ø55	
<i>Mite</i>	terra	Halo	E27	max 105	max Ø40	
<i>New Buds</i>	sospensione	LED retrofit / Fluo / Halo	E27	max 150	max Ø60	
<i>Nuage</i>	soffitto/parete	Fluo	2GX13 T16-R	300/230	Ø16	
<i>Orbital</i>	terra	Halo	E14	max 85	max Ø45	
<i>O-Space</i>	sospensione	Halo	R7s	78		
<i>Planet</i>	sospensione	LED retrofit / Fluo / Halo	E27		max Ø180	
<i>Plass media</i>	tavolo	LED retrofit / Fluo / Halo	E27		max Ø60	
<i>Plass media</i>	sospensione	LED retrofit / Fluo / Halo	E27		max Ø60	
<i>Plass grande</i>	sospensione	Halo	G9/GU10 PAR		max Ø60 (GU10 PAR)	
<i>Polygregg grande</i>	tavolo	LED retrofit / Fluo	E27		max Ø60	
<i>Gregg outdoor xl - grande</i>	tavolo/terra out./ sosp. out.	LED retrofit / Fluo	E27		max Ø60	
<i>Polygregg media</i>	tavolo	LED retrofit / Fluo	E27	max 140	max Ø60	
<i>Gregg outdoor media</i>	tavolo/terra out./sosp. out.	LED retrofit / Fluo	E27	max 140	max Ø60	
<i>Rituals 1-2-3 G9</i>	tavolo/sospensione	Halo	G9			
<i>Rituals 1-2-3 E27</i>	tavolo/sosp./soffitto/parete	LED retrofit / Fluo / Halo	E27	max 110	max Ø70	
<i>Rituals xl</i>	tavolo/sospensione	LED retrofit / Fluo / Halo	E27	max 140	max Ø60	
<i>Solar</i>	outdoor	LED retrofit / Fluo	E27	max 135	max Ø150	
<i>Stewie</i>	terra	Fluo	2GX13 T16-R	300	Ø16	
<i>Supernova</i>	sospensione	LED retrofit / Fluo	E27	max 160	max Ø120	
<i>Tartan</i>	sospensione	LED retrofit / Fluo / Halo	E27		max Ø60	
<i>Tite</i>	sospensione	LED retrofit / Fluo / Halo	E27		max Ø150	
<i>Tivu grande</i>	soffitto/parete	Fluo	2G11	max 533	Ø34	
<i>Tivu piccola</i>	parete	Halo	G9			
<i>Tress stilo</i>	terra	Halo	E27-PAR	max 100	100	
<i>Tress grande</i>	sospensione	Halo	R7s	118		
<i>Tress</i>	parete	Halo	R7s	78		
<i>Tress media/piccola</i>	tavolo/terra/sospensione	LED retrofit / Halo	E27/E27 PAR		max Ø150	
<i>Tress grande</i>	terra	Halo	R7s/E27 PAR	118 (R7s)	max Ø150 (E27 PAR)	
<i>Tress mini</i>	tavolo/sospensione	LED retrofit / Halo	GU10-PAR		max Ø150	
<i>Troag 1-2-3</i>	sospensione	Fluo	G5	1449/1149/849	Ø16	
<i>Tropico Vertical</i>	sospensione	Fluo	2G11	max 565	Ø34	
<i>Tropico Sphera /Ellipse</i>	sospensione	Fluo	2G24q-4	max 153	Ø34	
<i>Tutù</i>	parete	LED retrofit / Fluo / Halo	E14	max 85	max Ø40	
<i>Twiggy</i>	tav./ter./lettura/sosp./soffitto	LED retrofit / Fluo / Halo	E27	max 130	max Ø75	
<i>Uto</i>	tavolo/sospensione/outdoor	LED retrofit / Fluo	E27	max 160	max Ø100	
<i>Yoko</i>	tavolo	LED retrofit / Fluo	E27	max 160	max Ø70	
<i>Wave</i>	sospensione	Halo	R7s	78		

Foscarini SpA

via delle Industrie 27
30020 Marcon / Venezia / Italy
T +39 041 595 3811
F +39 041 595 3820
foscarini@foscarini.com

Foscarini Inc

17 Greene Street, New York
NY /10013 / USA
T +1 212 247 2218
F +1 646 545 2564
foscarini.inc@foscarini.com

Foscarini Spazio Brera

via Fiori Chiari 28 /
via Pontaccio 19
20121 / Milano / Italy
T +39 02 870 71320
spaziobrera@foscarini.com

Foscarini Spazio Soho

17 Greene Street, New York
NY /10013 / USA
T +1 212 257 4412
spaziosoho@foscarini.com

Azienda certificata
UNI EN ISO 9001
UNI EN ISO 14001

edition 11.2015

Concept and graphic design:
Designwork
art direction: Artemio Croatto
art work: Erika Pittis / Designwork

Photography:
Massimo Gardone /Azimut

Printed in Italy
Grafiche GFP

foscarini.com

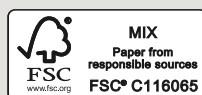

FOSCARINI